

REPUBLIQUE DU CAMEROUN

Paix - Travail - Patrie

AUTORITE AERONAUTIQUE

Le Directeur Général



REPUBLIC OF CAMEROON

Peace – Work – Fatherland

CAMEROON CIVIL AVIATION AUTHORITY

The Director General

CIRCULAR N° 000022 /C/CCAA/DG of 25 NOV 2020

**Laying down specifications for the presentation of the electronic
Aeronautical Information Publication (eAIP)**

TABLE OF CONTENTS

1. Introduction	4
1.1. Subject	4
1.2. Applicability	4
1.3. Description of changes	5
2. Requirements and References	5
2.1. Requirements	5
2.2. Reference documents	5
3. Definitions and abbreviations	5
4. Context	7
5. Intended Benefits of the eAIP to the stakeholders	7
5.1. Intended benefits to users of an eAIP	8
5.2. Intended benefits to producers of eAIP	8
6. Compliance to regulation	8
6.1. Compliance to ICAO regulations	8
6.2. Testing and Verification	8
6.3. Transition and coexistence of eAIP and paper AIP	9
7. Contact	9
1. Appendix 1: CONVENTIONS USED IN THE EAIP SPECIFICATIONS	10
1.1. Introduction	10
1.2. Classification	10
1.3. Identification	10
2. Appendix 2: SPECIFICATION FOR EAIP REQUIREMENTS	12
2.1. Introduction	12
2.2. eAIP Visualisation Requirements	12
3. Appendix 3: CONFORMITY MATERIAL	70

MM
MC

TABLE OF FIGURES

Figure 1: eAIP Window	12
Figure 2:Start Search Window	14
Figure 3: Search Results Window.....	15
Figure 4: eAIP History Page.....	16
Figure 5: Currently Effective Issue Section.....	17
Figure 6: Next Issues Section.....	19
Figure 7: Expired Issues (Archives) Section.....	20
Figure 8: Cover Page	22
Figure 9: Commands Pane.....	25
Figure 10: AIP Table of content.....	38
Figure 11: AMDT "Table of Contents"	42
Figure 12: SUPs "Table of Contents"	46
Figure 13: AIC Table of Contents	48
Figure 14: eAIP Content	51
Figure 15: GEN 0.2	53
Figure 16: Abbreviations of GEN 2.2.....	55
Figure 17: AIP Content Amendments.....	57
Figure 18: AMDT Content.....	59
Figure 19: AIP SUP Content	61
Figure 20: AIC Content	65

MY
m

1. INTRODUCTION

The purpose of this Circular is to provide acceptable means of compliance (AMC), among others, to establish compliance with the regulations and guidance material (GM) to support the interpretation of the regulations.

This Circular, by itself, does not establish, change or modify regulatory requirements or permit any violation, nor does it establish minimum standards.

1.1. Subject

- (1) The CCAA eAIP Specification is written to accompany the transition from AIS to AIM in Cameroon. Its purpose is to specify how AISPs in Cameroon can ensure that aeronautical information is made available to the next intended user in a way that allows content and format of those documents to be directly readable on a computer screen.
- (2) This aeronautical information includes the Aeronautical Information Publication (AIPs), AIP Amendments (AMDTs), AIP Supplements (SUPs) and Aeronautical Information Circulars (AICs).

1.2. Applicability

- (1) The eAIP refers to the AIP in electronic form that enables it to be visualised on a computer screen. This eAIP specification is therefore intended to provide requirements for the presentation of the eAIP only. Requirements associated with how the eAIP is produced, exchanged, and provided are excluded from this Specification.
- (2) This CCAA eAIP specification defines detailed requirements, recommendations, and a possible MoC for the aeronautical data and aeronautical information within the AIPs, AMDTs and SUPs to be made available, as a minimum: "in a way that allows the content and format of the documents to be directly readable on a computer screen. It covers the visual presentation of the eAIP. This includes the AIP, AMDTs, SUPs and AICs.
- (3) The presentation of charts including the text on these, is excluded from the CCAA eAIP specification. Charts need to comply with the International Civil Aviation Organisation (ICAO) Annex 4 [RD 8]
- (4) This eAIP specification is not intended to support digital Notice to Airmen (NOTAM) process, as digital NOTAM require a database of aeronautical information and is thus not reliant on the eAIP.
- (5) Data quality requirements for the data provided in the eAIP are not covered by this CCAA eAIP Specification.
- (6) The requirements for the possible MoC specified in this CCAA eAIP

Specification are included in appendix 3. They comprise mandatory requirements, as well as recommendations and optional elements, the implementation of the latter two being optional.

1.3. Description of changes

Not applicable.

2. REQUIREMENTS AND REFERENCES

2.1. Requirements

- (a) [RD 1] ICAO Convention on International Civil Aviation, Annex 15 - Aeronautical Information Services, Sixteenth Edition- July 2018.
- (b) [RD 5] Arrête N° 001303/MINT du 29 septembre 2006 portant Règlementation de la fourniture du service d'information aéronautique dans l'espace aérien et sur le territoire Camerounais.
- (c) [RD 6] Arrête N° 00711/MINT du 8 juin 2006 portant organisation des services de la circulation aérien au Cameroun.
- (d) [RD 7] L'instruction 1298/MINT du 29 septembre 2006 portant organisation de la fourniture des services d'information aéronautique et des cartes aéronautiques dans l'espace aérien et sur le territoire camerounais.
- (e) [RD 8] ICAO Convention on International Civil Aviation, Annex 4 – Aeronautical Charts, Eleventh Edition – July 2009.

2.2. Reference documents

- (a) [RD 2] ICAO doc 8126 - Aeronautical Information Services Manual, Sixth Edition, 2003.
- (b) [RD 3] ICAO doc 10066 – Procedure for Air Navigation Services - Aeronautical Information Management (PANS-AIM), First Edition, 2018.
- (c) [RD 4] ISO 639 – Codes for the representation of names of languages
- (d) [RD 9] ICAO doc 8400, ICAO Abbreviations and Codes, Eighth Edition – 2010.
- (e) [RD 10] Plan national de transition du service d'information aéronautique (AIS) à la gestion de l'information aéronautique (AIM) au Cameroun du 09 novembre 2018, Edition 1.0.
- (f) [RD 11] Eurocontrol specification for Electronic Aeronautical Information Publication, edition 2.1, October 2015.

3. DEFINITIONS AND ABBREVIATIONS

- (1) The following definitions are used in this circular:

- (a) **Aeronautical information products:** Aeronautical data and aeronautical information provided either as digital data sets or as a standardized presentation in paper or electronic media.
 - (b) **AIC:** A notice containing information that does not qualify for the origination of a NOTAM or for inclusion in the AIP, but which relates to flight safety, air navigation, technical, administrative or legislative matters.
 - (c) **AIP:** A publication issued by or with the authority of the state and containing aeronautical information.
 - (d) **AIRAC:** An acronym (Aeronautical Information Regulation and Control) signifying a system aimed at advance notification based on common effective dates, of circumstances that necessitate significant changes in operating practices
 - (e) **AMDT:** Permanent changes to the information contained in the AIP
 - (f) **eAIP:** A version of the AIP that is published in a structured electronic format, the content of which can be viewed on a computer screen.
 - (g) **Linked text:** A linked text is a text that provides a hyperlink to other related text that will be opened when the linked text is clicked.
 - (h) **MoC element:** A means of compliance to a regulatory requirement.
 - (i) **Next Intended User:** The entity that receives the aeronautical information from the aeronautical information service provider.
 - (j) **NOTAM:** A notice distributed by means of telecommunication containing information concerning the establishment, condition or change in any aeronautical facility, service, procedure or hazard, the timely knowledge of which is essential to the personnel concerned with flight operations.
 - (k) **SUP:** Temporary changes to the information contained in the AIP, which are published by means of special pages.
- (2) The following abbreviations are used in this circular:
- (a) **AFS:** Aeronautical Fixed Service
 - (b) **AIC:** Aeronautical Information Circular
 - (c) **AIM:** Aeronautical Information Management
 - (d) **AIP:** Aeronautical Information Publication
 - (e) **AIRAC:** Aeronautical Information Regulation and Control
 - (f) **AIS:** Aeronautical Information Service
 - (g) **AISP:** Aeronautical Information Service Provider

- (h) **AMPT:** AIP Amendment
- (i) **ATM:** Air Traffic Management
- (j) **eAIP:** electronic AIP
- (k) **CD:** Compact Disk
- (l) **GEN:** General aspects of the eAIP
- (m) **HMI:** Human-Machine Interface
- (n) **HTML:** Hypertext Mark-up Language
- (o) **ICAO:** International Civil Aviation Organisation
- (p) **MoC:** Means of Compliance
- (q) **NOTAM:** Notice to Airmen
- (r) **PDF:** Portable Document Format
- (s) **PIB:** Pre-flight Information Bulletin
- (t) **SARPs:** Standards and Recommended Practices
- (u) **SUP:** AIP Supplement
- (v) **VFR:** Visual Flight Rules
- (w) **XML:** Extensible Mark-up Language.

4. CONTEXT

- (1) The eAIP plays an important role in the national plan for the transition from AIS to AIM conceived and adopted by the CCAA. This specification represents the first project (P11-1) of step 11 (P11) in phase 2 -- going digital.
- (2) The eAIP is considered as a tool that will bring more quality, efficiency and economy in the provision of Aeronautical Information Services (AIS).
- (3) The CCAA in a bid to ensure harmonisation, interoperability and coordination in the implementation of eAIP has put forward in this document the specifications for the presentation of the eAIP.
- (4) This specification is designed to enable the harmonised visualisation of the contents of the AIP, which has to be provided by the national Aeronautical Information Services (AIS) in accordance with the ICAO Convention on International Civil Aviation, in electronic form.
- (5) In the Cameroonian context, the CCAA aims to use this eAIP specification as a tool to increase and standardise the use of automation in AIS by promoting electronic versions to replace the current paper-based elements of aeronautical information products.

5. INTENDED BENEFITS OF THE EAIP TO THE STAKEHOLDERS

5.1. Intended benefits to users of an eAIP

- (1) possibility to visualise changes, both in text and graphics;
- (2) no maintenance effort;
- (3) no postal delays, when distributed through the Internet or equivalent private networks; available at hand for the whole company (no need to go to the library);
- (4) easy archiving;
- (5) proven authenticity of the document (if digitally signed by the issuing AIS).

5.2. Intended benefits to producers of eAIP

- (1) better AIP (consistency, integrity, usability);
- (2) the majority of the subscribers do no longer ask for paper amendments;
- (3) technological leap forward;
- (4) reduced risk and cost as compared to isolated development;
- (5) reduced costs for internal copies;
- (6) easier to create integrated/regional AIPs;
- (7) easy archiving (better support for legal proceedings);
- (8) possibility to guarantee the integrity and the authenticity of the document by digital signatures.

6. COMPLIANCE TO REGULATION

6.1. Compliance to ICAO regulations

- (1) The CCAA eAIP specification is fully compliant with the ICAO requirements for AIP content and structure, as laid down in the Annex 15 to the Convention on International Civil Aviation – Aeronautical Information Services. It provides:
 - (a) a standardised way to publish the content of Aeronautical Information Publication (AIP) in a structured electronic format;
 - (b) a recommended way to publish the content of AIP Amendments (AMDT), AIP Supplements (SUP) and Aeronautical Information Circulars (AIC) in a structured electronic format; and
 - (c) a recommended way to visualise the content of these electronic documents on a computer screen using web technology.

6.2. Testing and Verification

- (1) To achieve compliance with the MoC detailed in the CCAA eAIP specification, the mandatory requirements should be implemented and

conformance against these tested.

6.3. Transition and coexistence of eAIP and paper AIP

- (1) Traditionally, aeronautical information necessary to support international flight was made available by Cameroon AIS and ASECNA, by way of manually typed document, the AIP. However, Cameroon has recognised the importance of aeronautical information as a core component of the future ATM as demonstrated in her plan for the transition from AIS to AIM.
- (2) This transition will cause a shift from manual processes, paper-based products and services to automated data processing and digital services. In this new environment, aeronautical data/information is maintained in digital form, from the point of origination through the point of use, be it on-board an aircraft or in an ATM system. With this move, Cameroon has decided to transition to electronic AIP, which will allow end users to visualize most of the AIS information on computer screens.
- (3) Moving towards electronic documents introduces new capabilities, such as fast search, hyperlinks, dynamic presentation of changes in text and graphics etc. This also comes with constraints, typically related to the page layout and the encoding format. Former paper documents specifications need to be adapted in the new digital environment.
- (4) When the transition is made from paper-based to electronic media, the eAIP provides the following functionality:
 - (a) The comparison of previous and modified versions, where amendments modify text;
 - (b) The possible incorporation of links from disseminated versions, for example on CD, to NOTAM on live websites (However, because of their transient nature, NOTAM themselves would not be appropriate for disseminated versions);
 - (c) The verification of effective dates for each section and where possible, the source of the information;
 - (d) The linking of cross-references within the body of the text;
 - (e) The ability to scale and zoom in and out of charts.

7. CONTACT

- (1) For more information, please contact: contact@ccaa.aero
- (2) Any suggestion to modify this circular will be highly appreciated and can be submitted via the above-mentioned email address.



1. APPENDIX 1: CONVENTIONS USED IN THE EAIP SPECIFICATIONS

1.1. Introduction

This CCAA eAIP specification provides a minimum subset of requirements necessary for the correct and harmonised implementation of the eAIP. Some recommendations are also made that are optional. The mandatory requirements made within this CCAA eAIP specification document are clearly distinguished from optional recommendations and optional elements. This distinction is made through the details provided in appendix 2 and through the conformity material provided in appendix 3.

1.2. Classification

(1) The conventions for denoting requirements, recommendations and optional elements are as follows:

- **“Shall”**- indicates a statement of specification, the compliance of which is mandatory to achieve the implementation of CCAA eAIP Specification. Such requirements shall be testable and their implementation auditable.
- **“Should”**- indicates a recommendation which may or may not be satisfied by all systems claiming conformity to this specification.
- **“May”**- Indicates an optional element.

(2) In appendix 2 and appendix 3, the requirements are classified into three:

- **“M”** (Mandatory) for “shall” items;
- **“O”** (Optional) for “should” or “may” items;
- **“C”** (Conditional) for items when an optional parent requirement has been implemented. Conditional items provide more detailed requirements/optional elements about how the parent requirement is to be implemented.

1.3. Identification

(1) Every requirement and recommendation in this specification is denoted by an identifier structured in a specific manner. This identifier is used to reference the requirement/recommendation uniquely. These identifiers have the form:

eAIP-[Fn]-[nnn]

where:

- [Fn]: is a sequence of characters to identify the functional area to which the requirement applies. e.g “GEN” for requirements related to the general aspects of the eAIP.
- [nnn]: is a numeric identifier for a sequence of requirements within the same functional area.

(2) The functional areas referred to in appendix 2 and appendix 3 are:

- GEN: General aspects of the eAIP;
- SRCH: The Search facility;
- HIST: The History page of the eAIP;
- COV: The cover page of the eAIP;
- MENU: the eAIP menu;
- AIPT: The "AIP Table of Contents";
- AMDTT: The AMDT "Table of Contents";
- SUPT: The SUP "Table of Contents";
- AICT: The AIC "Table of Contents";
- HELP: The help facility;
- AIPC: The AIP content;
- AMDTC: The AMDT content;
- SUPC: The SUP content;
- AICC: The AIC content;
- DIST: The Distribution of the eAIP;
- CONF: The client configuration settings.

(3) In most cases, the requirements are at a high-level and apply to multiple sections and pages of the eAIP. However, it has been necessary to specify requirements for specific section or sections of the eAIP in some cases. This is mainly where these sections are unique in their content or layout.

2. APPENDIX 2: SPECIFICATION FOR EAIP REQUIREMENTS

2.1. Introduction

The conventions used here are explained in appendix 1 to this circular.

2.2. eAIP Visualisation Requirements

The CCAA specification for eAIP requirements for the visualisation and functionality of the AIP in electronic form adhere to the ICAO Annex 15[RD 1] requirements for:

- The structure and layout of the AIP;
- The AIRAC cycle requirements;
- The indication of the amendments (alterations, additions and deletions) to the AIP in the last AIRAC cycle.

2.2.1 General

The figure below expresses the general requirements associated with the display of the eAIP.

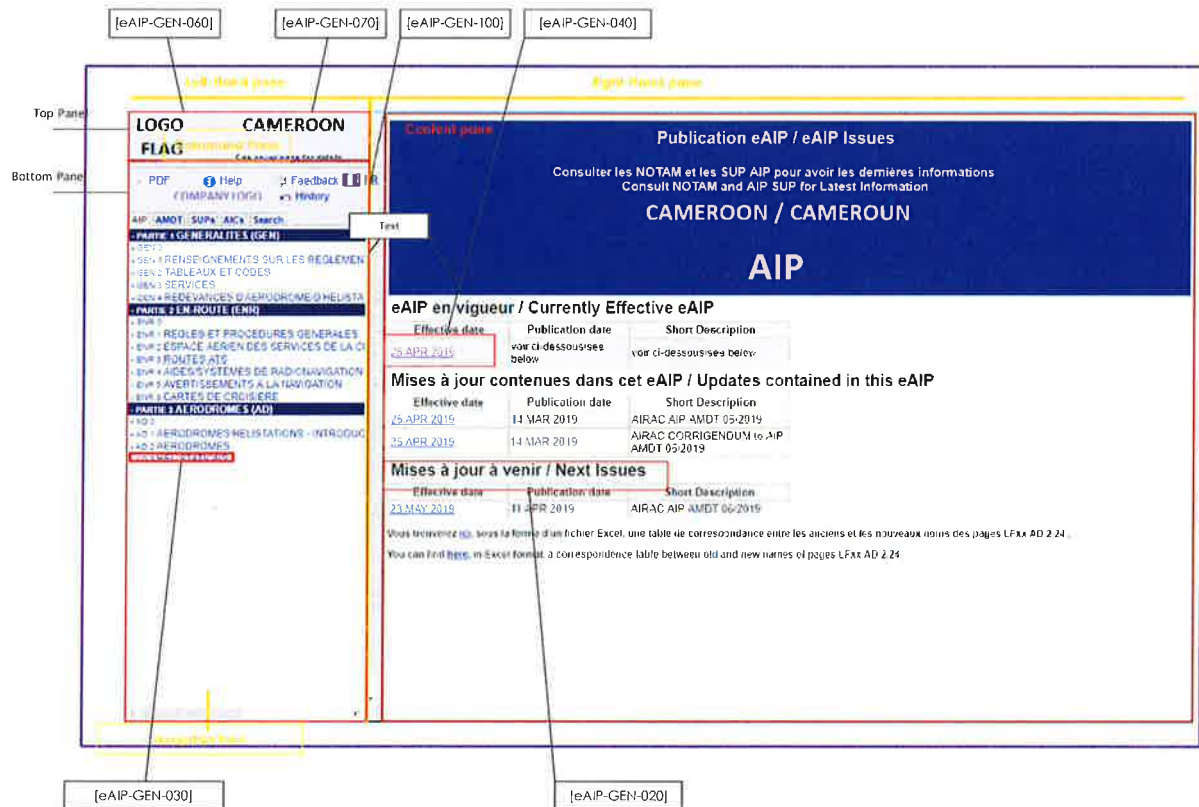

Figure 1: eAIP Window

Handwritten initials/signature

[eAIP-GEN-010]	Unless otherwise stated for specific elements, all eAIP text including headings shall be displayed in black (RGB Hexadecimal Value: 000000) on a white (RGB Hexadecimal Value: ffffff) background.	M
[eAIP-GEN-020]	Unlinked eAIP text shall be black (RGB Hexadecimal Value: 000000).	M
[eAIP-GEN-030]	The display of all hyperlinks shall be based on the settings of the client's browser	M
[eAIP-GEN-040]	Dates shall be displayed in the format DD MMM YYYY, for example 25 JAN 2019.	M
[eAIP-GEN-050]	The eAIP shall be displayed in a window consisting of three panes: The Command pane, the Navigation pane and the Content pane.	M
[eAIP-GEN-060]	The Command pane of the eAIP window shall contain navigation menu for the eAIP.	M
[eAIP-GEN-070]	The Navigation pane of the eAIP window shall contain the navigation menu for the eAIP.	M
[eAIP-GEN-080]	The Content pane of the eAIP window shall contain the cover page of the eAIP when the eAIP is initially opened.	M
[eAIP-GEN-090]	The content pane of the eAIP window shall contain the relevant content of the eAIP when selected by the user in the Navigation pane.	M
[eAIP-GEN-100]	The user shall be able to change the ratios occupied by the left-hand and right-hand panes of the eAIP window by moving the splitter.	M
[eAIP-GEN-110]	Scrollbars shall be made available in the Navigation pane when the content exceeds the size of the pane, to allow the user to view all the content.	M
[eAIP-GEN-120]	The information content of the eAIP and paper AIP, with the same effective dates shall be the same.	M
[eAIP-GEN-130]	The most current update cycles applicable to AIP amendments and AIP supplements shall be made	M

	publicly available via the eAIP.	
--	----------------------------------	--

2.2.2 Search Facility

2.2.2.1 Start Search

The figure below depicts the requirements associated with the display of the search facility.

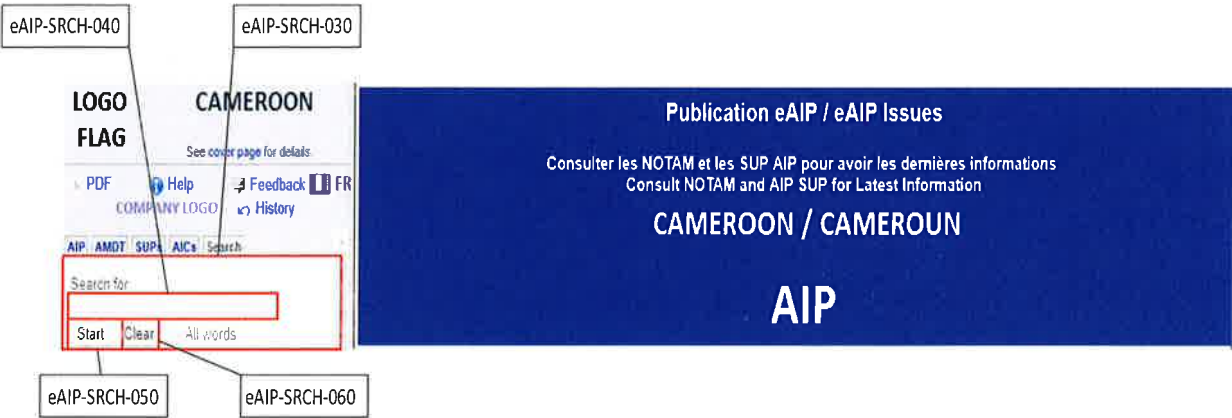

Figure 2:Start Search Window

[eAIP-SRCH-010]	The Search facility should be platform independent. Parent requirement: [eAIP-MENU-230].	C
[eAIP-SRCH-020]	The Search facility should be independent of the distribution means employed. Parent requirement: [eAIP-MENU-230].	C
[eAIP-SRCH-030]	When launched, a Search page should appear in the Navigation pane. Parent requirement: [eAIP-MENU-230].	C
[eAIP-SRCH-040]	The Search facility should have a "Search for" edit box in which the user may type the sequence of characters to be found. Parent requirement: [eAIP-MENU-230].	C
[eAIP-SRCH-050]	The Search page should have a Start button. Parent requirement: [eAIP-MENU-230].	C
[eAIP-SRCH-060]	The Search page should have a Clear button to clear the content of the "Search for" edit box.	C

Parent requirement: [eAIP-MENU-230].

2.2.2.2 Search Results

The figure below depicts the requirements associated with the display of the search results.

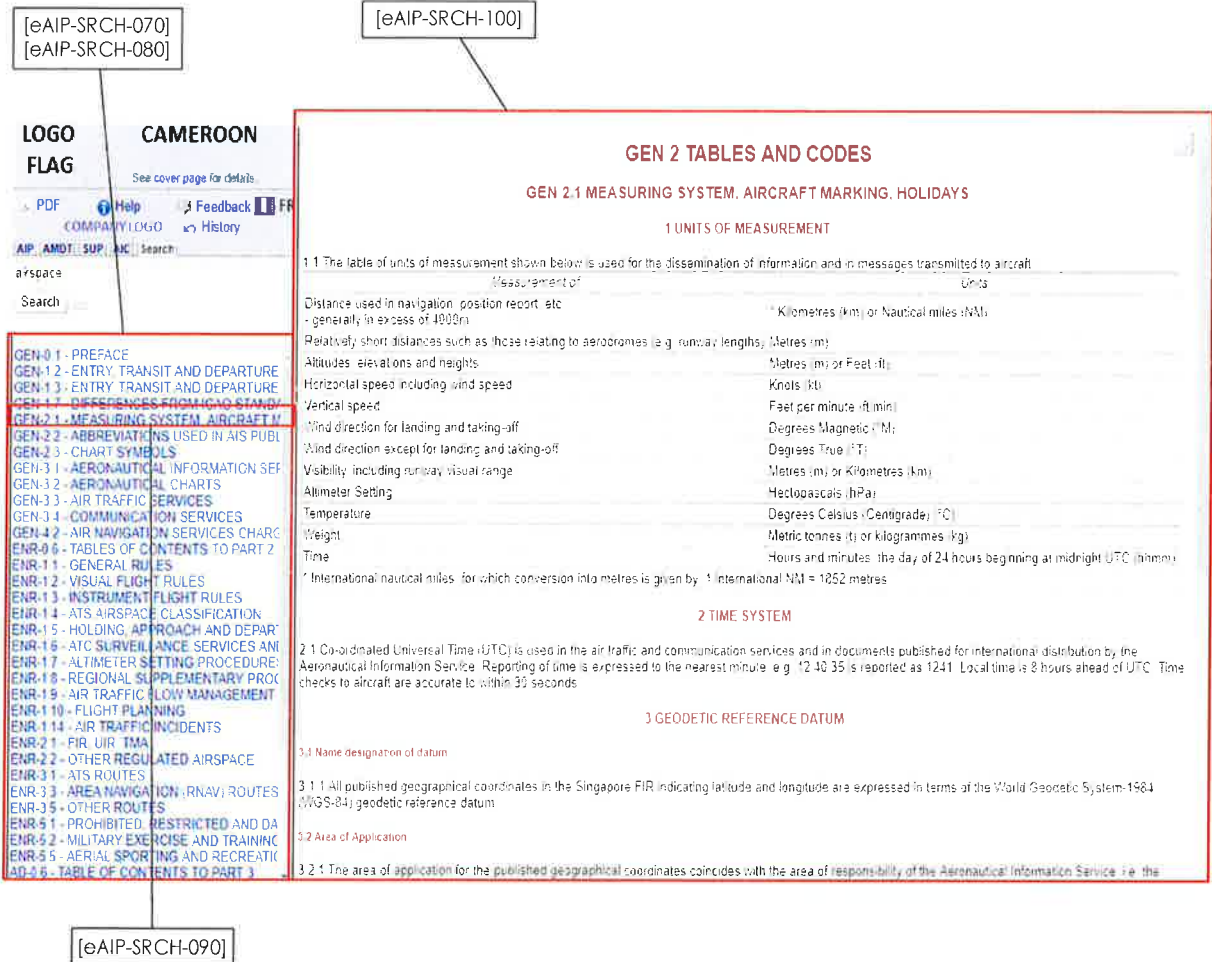

Figure 3: Search Results Window

[eAIP-SRCH-070]	When the user clicks the Start button, the Search facility should return the results in the Navigation pane. Parent requirement: [eAIP-MENU-230].	C
[eAIP-SRCH-080]	There should be an entry in the Navigation pane, for each section/subsection that contains the required sequence of characters. Parent requirement: [eAIP-MENU-230].	C
[eAIP-SRCH-090]	Each result entry in the Navigation pane should be a link.	C

MP
MC

	Parent requirement: [eAIP-MENU-230].	
[eAIP-SRCH-100]	If the user clicks the entry link in the Navigation pane, that section/sub-section of the eAIP should be displayed in the Content pane of the eAIP window. Parent requirement: [eAIP-MENU-230].	C

2.2.3 eAIP History Page

2.2.3.1 General

The figure below depicts the requirements associated with the display of the eAIP History page.

The screenshot shows the eAIP History page for Cameroon. At the top, there is a blue header with the text "Publication eAIP / eAIP Issues" and "CAMEROON / CAMEROUN". Below this, there is a section titled "eAIP en vigueur / Currently Effective eAIP" with a table of effective dates and descriptions. Below that is a section titled "Expired Issues (Archives)" with a table of expired dates and descriptions. At the bottom, there is a section titled "Mises à jour à venir / Next Issues" with a table of upcoming dates and descriptions. Callouts from requirements [eAIP-HIST-070] through [eAIP-HIST-040] point to various elements on the page, including the header, the "AIP" logo, and the tables.

Figure 4: eAIP History Page

[eAIP-HIST-010]	A static eAIP History page may be provided on media used to disseminate the eAIP.	O
[eAIP-HIST-020]	The eAIP History page shall have the title "eAIP Issues". Parent requirement: [eAIP-HIST-010].	C
[eAIP-HIST-030]	The eAIP History page shall indicate which state has issued the eAIP. Parent requirement: [eAIP-HIST-010].	C

[eAIP-HIST-040]	The eAIP History page may include the logo of the organisation responsible for publishing the eAIP. Parent requirement: [eAIP-HIST-010].	C
[eAIP-HIST-050]	The eAIP History page shall advise the user to consult NOTAM for the latest information. Parent requirement: [eAIP-HIST-010].	C
[eAIP-HIST-060]	The eAIP History page shall provide the name of the organisation responsible for publishing the eAIP. Parent requirement: [eAIP-HIST-010].	C
[eAIP-HIST-070]	The eAIP History page shall include a Currently Effective Issue section. Parent requirement: [eAIP-HIST-010].	C
[eAIP-HIST-080]	The eAIP history page should include a Next Issues section. Parent requirement: [eAIP-HIST-010].	C
[eAIP-HIST-090]	The eAIP History page should include an Expired Issues (Archives) section. Parent requirement: [eAIP-HIST-010].	C

2.2.3.2 Currently Effective Issue Section

The figure below expresses the requirements associated with the display of the Currently Effective Issue section of the eAIP History page.

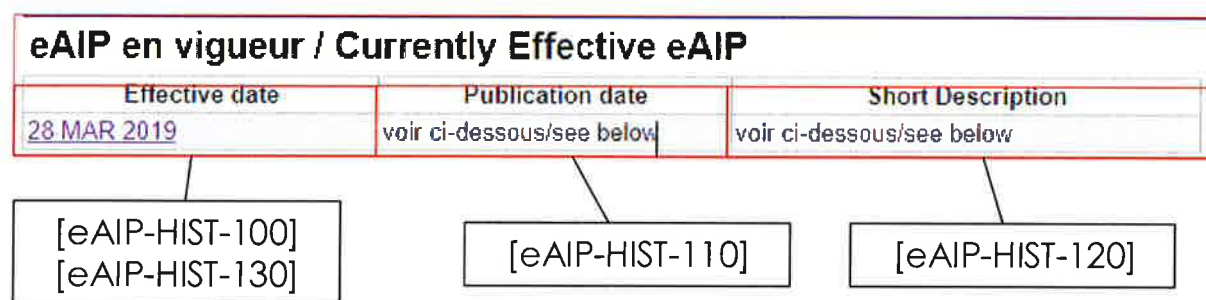

Figure 5: Currently Effective Issue Section

[eAIP-HIST-100]	On the eAIP History page, the Currently Effective Issue section shall contain a table with an Effective	C
-----------------	---	---

	Date column. Parent requirement: [eAIP-HIST-010].	
[eAIP-HIST-110]	On the eAIP History page, the Currently Effective Issue section shall contain a table with Publication Date column. Parent requirement: [eAIP-HIST-010].	C
[eAIP-HIST-120]	On the eAIP History page, the Currently Effective Issue section shall contain a table with a Reason for Change column. Parent requirement: [eAIP-HIST-010].	C
[eAIP-HIST-130]	In the Currently Effective Issue section of the eAIP History page, the date in the Effective Date column of the table shall be a link. Parent requirement: [eAIP-HIST-010].	C
[eAIP-HIST-140]	In the Currently Effective Issue section of the eAIP History page, the Effective Date link shall be to the eAIP with the Effective Date in the table. Parent requirement: [eAIP-HIST-010].	C
[eAIP-HIST-150]	In the Currently Effective Issue Section of the eAIP History page, when the link is clicked, the cover page of the eAIP with the relevant Effective Date shall open in the currently open and active window. Note: See Figure 8: Cover Page. Parent requirement: [eAIP-HIST-010].	C

2.2.3.3 Next Issues Section

The figure below represents the requirements associated with the display of the Next Issues section of the eAIP History page.

Mises à jour à venir / Next Issues

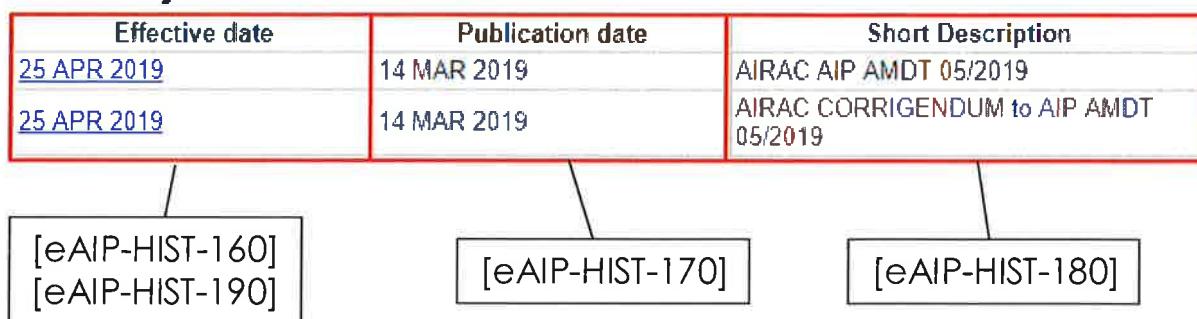

Figure 6: Next Issues Section

[eAIP-HIST-160]	On the eAIP History page, the Next Issues section shall contain a table with an Effective date column. Parent requirements: [eAIP-HIST-010] and [eAIP-HIST-080].	C
[eAIP-HIST-170]	On the eAIP History page, the Next Issues section shall contain a table with the Publication Date column. Parent requirements: [eAIP-HIST-010] and [eAIP-HIST-080].	C
[eAIP-HIST-180]	On the eAIP History page, the Next Issues section shall contain a table with a Reason for Change column. Parent requirements: [eAIP-HIST-010] and [eAIP-HIST-080].	C
[eAIP-HIST-190]	In the Next Issues section of the eAIP History page, the date in the Effective Date column shall be a link. Parent requirements: [eAIP-HIST-010] and [eAIP-HIST-080].	C
[eAIP-HIST-200]	In the Next Issues section of the eAIP History page, the Effective Date link shall be to the eAIP with the effective Date in the table. Parent requirements: [eAIP-HIST-010] and [eAIP-HIST-080].	C
[eAIP-HIST-210]	In the Next Issues section of the eAIP History page, when the link is clicked, the cover page of the eAIP with the relevant effective Date that has been finalised and approved for publication, shall open in	C

	<p>the currently open and active window.</p> <p>Parent requirements: [eAIP-HIST-010] and [eAIP-HIST-080].</p> <p>Note: See Figure 8: Cover Page.</p>	
--	--	--

2.2.3.4 Expired Issues (Archives)

The figure below reflects the requirements related to the display of the Expired Issues (Archives) section of the eAIP History page.

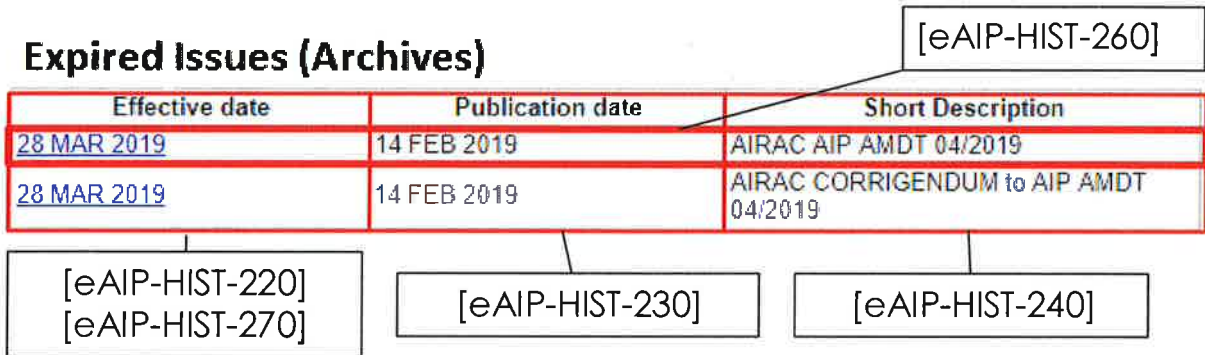

Figure 7: Expired Issues (Archives) Section

[eAIP-HIST-220]	<p>On the eAIP History page, the Expired Issues (Archives) section shall contain a table with an Effective Date column.</p> <p>Parent requirements: [eAIP-HIST-010] and [eAIP-HIST-090].</p>	C
[eAIP-HIST-230]	<p>On the eAIP History page, the Expired Issues (Archives) section shall contain a table with a Publication Date column.</p> <p>Parent requirements: [eAIP-HIST-010] and [eAIP-HIST-090].</p>	C
[eAIP-HIST-240]	<p>On the eAIP History page, the Expired Issues (Archives) section shall contain a table with a Reason for Change column.</p> <p>Parent requirements: [eAIP-HIST-010] and [eAIP-HIST-090].</p>	C
[eAIP-HIST-250]	<p>On the eAIP History page, the Expired Issues (Archives) section shall contain a warning that these past amendments are provided for information purpose and are not to be used</p>	C

	operationally. Parent requirements: [eAIP-HIST-010] and [eAIP-HIST-090].	
[eAIP-HIST-260]	On the eAIP History page, the Expired Issues (Archives) section shall contain a record of the recently expired issues. Parent requirements: [eAIP-HIST-010] and [eAIP-HIST-090].	C
[eAIP-HIST-270]	In the Expired Issues (Archives) section of the eAIP History page, the date in the Effective Date column may be a link. Parent requirements: [eAIP-HIST-010] and [eAIP-HIST-090].	C
[eAIP-HIST-280]	In the Expired Issues (Archives) section of the eAIP History page, the Effective Date link shall be to the eAIP with the Effective date in the table. Parent requirements: [eAIP-HIST-010] and [eAIP-HIST-090].	C
[eAIP-HIST-290]	In the Expired Issues (Archives) section of the eAIP History page, when the link is clicked, the cover page of the eAIP with the relevant Effective Date shall open in the currently open and active window Parent requirements: [eAIP-HIST-010] and [eAIP-HIST-090].	C

2.4 eAIP Cover Page

The figure below demonstrates the requirements associated with the display of the eAIP Cover Page.

MR
OR

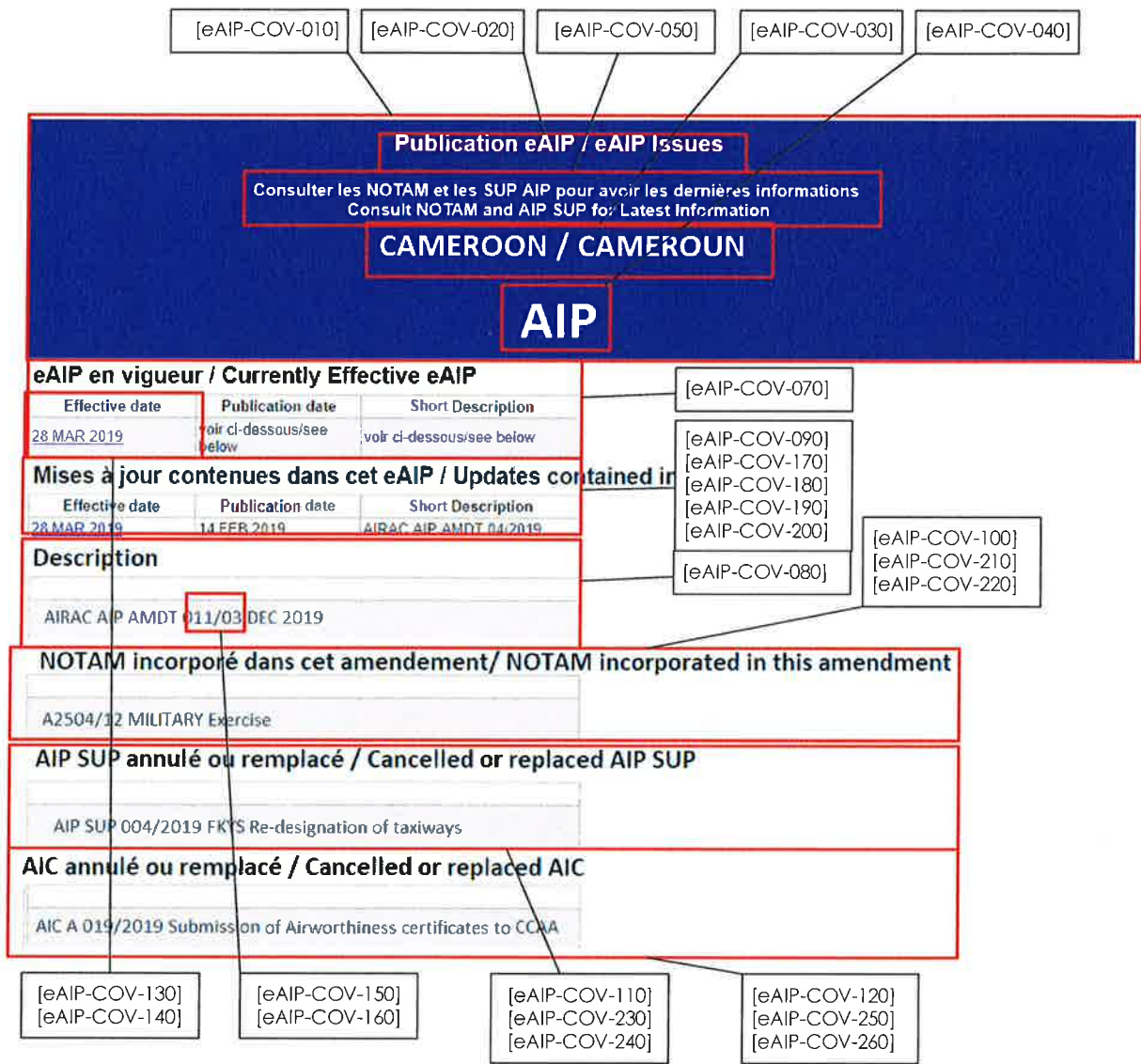

Figure 8: Cover Page

[eAIP-COV-010]	When an eAIP is first opened, the Content pane of the eAIP window (cover page) shall have a header	M
[eAIP-COV-020]	When an eAIP is first opened, the header of the Content pane of the eAIP window (cover page) shall have a title indication that it is an eAIP	M
[eAIP-COV-030]	When an eAIP is first opened, the header of the Content pane of the eAIP window (cover page) shall indicate for which state the eAIP is.	M
[eAIP-COV-040]	When an eAIP is first opened, the header of the Content pane of the eAIP window (cover page) may contain the logo of the publishing organisation.	O
[eAIP-COV-050]	When an eAIP is first opened, the header of the Content pane of the eAIP window (cover page) shall	M

Handwritten signature

	contain a warning that NOTAM should be consulted for the latest information.	
[eAIP-COV-060]	When an eAIP is first opened, the header of the Content pane of the eAIP window (cover page) shall contain the name of the publishing organisation.	M
[eAIP-COV-070]	When an eAIP is first opened, the Content pane of the eAIP window (cover page) should contain an "Information on this eAIP Package" section.	O
[eAIP-COV-080]	When an eAIP is first opened, the Content pane of the eAIP window (cover page) should contain a "Description" section.	O
[eAIP-COV-090]	When an eAIP is first opened, the Content pane of the eAIP window (cover page) should contain a "Changes in this Issue" section.	O
[eAIP-COV-100]	When an eAIP is first opened, the Content pane of the eAIP window (cover page) should contain a "NOTAM incorporated in this Amendment" section.	O
[eAIP-COV-110]	When an eAIP is first opened, the Content pane of the eAIP window (cover page) should contain a "Cancelled/Replaced AIP SUP" section.	O
[eAIP-COV-120]	When an eAIP is first opened, the Content pane of the eAIP window (cover page) should contain a "Cancelled/Replaced AIC" section.	O
[eAIP-COV-130]	When an eAIP is first opened, in the Content pane of the eAIP window (cover page), the "Information on this eAIP Package" section should include the Effective date of the eAIP.	O
[eAIP-COV-140]	When an eAIP is first opened, in the Content pane of the eAIP window (cover page), the "Information on this eAIP Package" section should include the Publication date of the eAIP.	O
[eAIP-COV-150]	When an eAIP is first opened, in the Content pane of the eAIP window (cover page), the "Description" section should include the AIRAC AIP Amendment number.	O

[eAIP-COV-160]	When an eAIP is first opened, in the of Content pane the eAIP window (cover page) the "Description" section should include the AIP Amendment number.	○
[eAIP-COV-170]	When an eAIP is first opened, in the Content pane of the eAIP window (cover page), the "Changes in this Issue" section should include an entry for each active SUP, with its number.	○
[eAIP-COV-180]	When an eAIP is first opened, the "Changes in this Issue" section in the Content pane of the eAIP window (cover page), may include the deadline for each active SUP entry.	○
[eAIP-COV-190]	When an eAIP is first opened, in the Content pane of the eAIP window (cover page), the "Changes in this Issue" section should include an entry for each active AIC, with its number.	○
[eAIP-COV-200]	When an eAIP is first opened, the "Changes in this Issue section" in the Content pane of the eAIP window (cover page) may include the headline for each active AIC entry.	○
[eAIP-COV-210]	When an eAIP is first opened, in the Content pane of the eAIP window (cover page), the "NOTAM incorporated in this Amendment" section should list the series/number of all PERM NOTAM incorporated in this eAIP Package.	○
[eAIP-COV-220]	When an eAIP is first opened, the "NOTAM incorporated in this Amendment" section in the Content pane of the eAIP window (cover page) may include the headline for each active PERM NOTAM entry.	○
[eAIP-COV-230]	When an eAIP is first opened, in the Content pane of the eAIP window (cover page), the "Cancelled/Replaced AIP SUP" section should list the numbers of any SUPs cancelled or replaced.	○
[eAIP-COV-240]	When an eAIP is first opened, in the Content pane of the eAIP window (cover page), the "Cancelled/Replaced AIP SUP" section may list the	○

	headlines of any SUPs cancelled or replaced.	
[eAIP-COV-250]	When an eAIP is first opened, in the Content pane of the eAIP window (cover page), the "Cancelled/Replaced AIC" section should list the numbers of AIC cancelled or replaced.	O
[eAIP-COV-260]	When and eAIP is first opened, in the Content pane of the eAIP window (cover page), the Cancelled/Replaced AIC" section may list the headlines of AIC cancelled or replaced.	O

2.5 eAIP Commands Pane

2.5.1 Commands pane presentation

The figure below reflects the requirements associated with the display of the Commands pane.

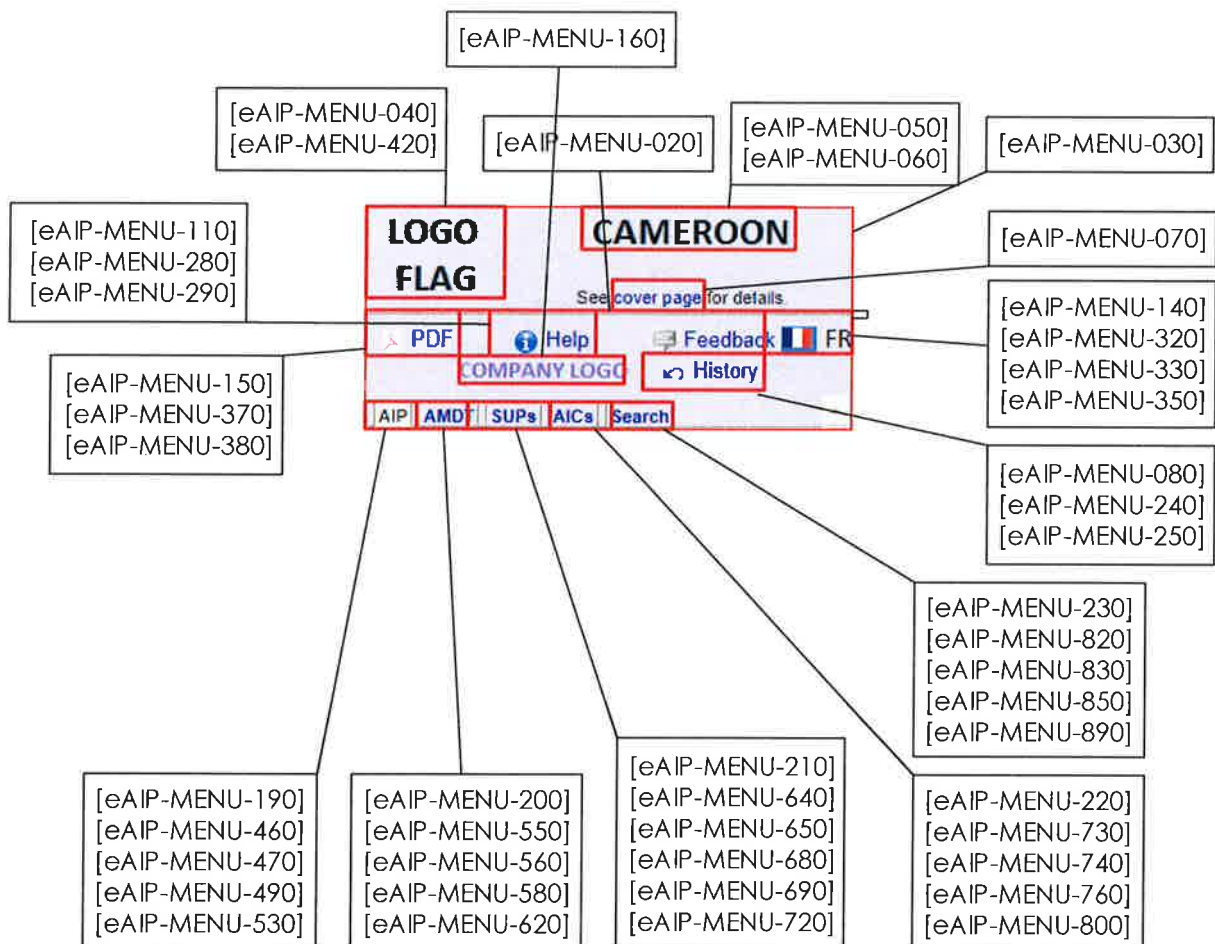

Figure 9: Commands Pane

[eAIP-MENU-010]	On the eAIP window, the menu shall be situated in	M
-----------------	---	---

	the Command pane, above the Navigation pane for the AIP, AMDTs, SUPs and AICs, and the Search page.	
[eAIP-MENU-020]	On the eAIP window, the Command pane shall be split by a horizontal line, dividing the Command pane into a top and bottom panel.	M
[eAIP-MENU-030]	On the eAIP window, the background colour of the panels on the Commands pane shall be grey (RGB Hexadecimal Value: cfcfdf).	O
[eAIP-MENU-040]	On the eAIP window, the top panel of the Commands pane may contain the logo of the publishing organisation or the national flag of the state.	M
[eAIP-MENU-050]	On the eAIP window, the top panel of the Commands pane shall contain the name of the State.	M
[eAIP-MENU-060]	On the eAIP window, the name of the State in the top panel of the Commands pane shall be black (RGB Hexadecimal Value:000000)	O
[eAIP-MENU-070]	On the eAIP window, the top panel of the Commands pane shall contain a link to the eAIP cover page.	M
[eAIP-MENU-080]	On the eAIP window, the top panel of the Commands pane shall contain a link to the eAIP history page. Parent requirement: [eAIP-HIST-010]	C
[eAIP-MENU-090]	On the eAIP window, the top panel of the Commands pane may contain a drop-down list of eAIPs available, listed by their effective date.	O
[eAIP-MENU-100]	In the Commands pane of the eAIP window, selecting from drop-down list of eAIPs available, shall open the cover page of the selected eAIP in the Content pane of the eAIP window. Note: See Figure 8: Cover Page. Parent requirement: [eAIP-HIST-090]	C

[eAIP-MENU-110]	On the eAIP window, the bottom panel of the Commands pane shall contain a link to a Help facility.	M
[eAIP-MENU-120]	The eAIP shall be made available in at least the English and French languages.	M
[eAIP-MENU-130]	The eAIP may be made available in other languages, in addition to English and French.	O
[eAIP-MENU-140]	On the eAIP window, the bottom panel of the Commands pane shall contain a link for each other language the eAIP is provided in.	M
[eAIP-MENU-150]	On the eAIP window, the bottom panel of the Commands pane may contain a link to the current section or document in PDF format.	O
[eAIP-MENU-160]	On the eAIP window, the bottom panel of the Commands pane may contain a link to the website of the publishing organisation.	O
[eAIP-MENU-170]	On the eAIP window, the bottom panel of the Commands pane may contain a link to enable the user to submit feedback on the AIP.	O
[eAIP-MENU-180]	From the Commands pane on the eAIP window, feedback may be made through direct contact or through a feedback form. Parent requirement: [eAIP-HIST-170]	C
[eAIP-MENU-190]	On the eAIP window, the Commands pane shall contain an "AIP" tabbed page.	M
[eAIP-MENU-200]	On the eAIP window, the Commands pane shall contain an "AMDT" tabbed page.	M
[eAIP-MENU-210]	On the eAIP window, the Commands pane shall contain a "SUPs" tabbed page.	M
[eAIP-MENU-220]	On the eAIP window, the Commands page shall contain an "AICs" tabbed page.	M
[eAIP-MENU-230]	On the eAIP window, the Commands pane should contain a "Search" tabbed page.	O

2.5.2 eAIP History Link

[eAIP-MENU-240]	On the eAIP window, the link of the eAIP history page in the Commands pane shall be titled "History" or the translation of this word, based on the language in which the eAIP is being viewed. Parent requirements: [eAIP-HIST-010] and [eAIP-HIST-080]	C
[eAIP-MENU-250]	On the eAIP window, the link to the eAIP history page in the Commands pane shall display an icon. Parent requirements: [eAIP-HIST-010] and [eAIP-HIST-080]	C
[eAIP-MENU-260]	On the eAIP window, clicking on the "History" link in the Commands pane shall open the eAIP History page in the active window. Note: See Figure 4: eAIP History Page. Parent requirements: [eAIP-HIST-010] and [eAIP-HIST-080]	C
[eAIP-MENU-270]	On the eAIP window, clicking on the "History" icon in the Commands pane shall open the eAIP History page in the active window. Note: See Figure 4: eAIP History Page. Parent requirements: [eAIP-HIST-010] and [eAIP-HIST-080]	C

Note: Please see 2.2.3 eAIP History Page

2.5.3 Help link

[eAIP-MENU-280]	On the eAIP window the link to the eAIP help page in the Commands pane shall be titled "Help" or the translation of this word, based on the language in which the eAIP is being viewed.	M
[eAIP-MENU-290]	On the eAIP window, the link to the eAIP help page in the Commands pane shall display a logo or	M

	image or icon.	
[eAIP-MENU-300]	On the eAIP window, clicking on the "Help" link on the Commands pane shall open the eAIP Help page in the Content pane of the eAIP window. Note: See section 2.10 Help Page	M
[eAIP-MENU-310]	On the eAIP window, clicking on the Help logo or image or icon in the Commands pane shall open the eAIP Help page in the Content pane of the eAIP window. Note: See section 2.10 Help Page	M

2.5.4 Language link

[eAIP-MENU-320]	On the eAIP window, the link in the Commands pane to the eAIP in a language shall have the abbreviated ISO language code as the title (See ISO 939 codes for the representation of languages [RD-1]) Parent requirements: [eAIP-HIST-130]	C
[eAIP-MENU-330]	On the eAIP window in the Commands pane, the language code shall be displayed in black (RGB Hexadecimal Value: 000000) for the currently selected language. Parent requirements: [eAIP-HIST-130]	C
[eAIP-MENU-340]	On the eAIP window in the Commands pane, the language code shall be displayed in light blue (RGB Hexadecimal Value:0000ff) for the unselected languages. Parent requirements: [eAIP-HIST-130]	C
[eAIP-MENU-350]	On the eAIP window in the Commands pane, the national flag associated with the language shall be displayed next to the ISO language code. Parent requirements: [eAIP-HIST-130]	C
[eAIP-MENU-360]	On the eAIP window, clicking on the language code or national flag in the Commands pane, shall open the currently selected section, in that	C

	language, in the Content pane of the eAIP window. Parent requirements: [eAIP-HIST-130]	
--	---	--

2.5.5 PDF link

[eAIP-MENU-370]	On the eAIP window in the Commands pane, the link to the current section or document in PDF format shall have "PDF" as the title. Parent requirements: [eAIP-HIST-150]	C
[eAIP-MENU-380]	On the eAIP window in the Commands pane, the link to the section or document in PDF should display the official Adobe Reader icon (PDF) Parent requirements: [eAIP-HIST-150]	C
[eAIP-MENU-390]	The use of the official Adobe Reader icon (PDF) shall be in accordance with Adobe Permissions and Trademark Guidelines Parent requirements: [eAIP-HIST-150]	C
[eAIP-MENU-400]	On the eAIP window, clicking on the "PDF" link in the Commands pane, shall open the current section or document in the PDF format. Parent requirements: [eAIP-HIST-150]	C
[eAIP-MENU-410]	On the eAIP window, clicking on the "PDF" icon in the Commands pane, shall open the current section or document in PDF format. Parent requirements: [eAIP-HIST-150]	C

2.5.6 Website link

[eAIP-MENU-420]	On the eAIP window in the bottom panel of the Commands pane, the link to the website of the publishing organisation shall have the name of that organisation. Parent requirements: [eAIP-HIST-160]	C
[eAIP-MENU-430]	On the eAIP window in the bottom panel of the Commands pane, the link to the website of the	C

	publishing organisation may also display the logo of that organisation. Parent requirements: [eAIP-HIST-160]	
[eAIP-MENU-440]	On the eAIP window, clicking on the name of the organisation in the bottom panel of the Commands pane shall open the organisation's website, in a separate window. Parent requirements: [eAIP-HIST-160]	C
[eAIP-MENU-450]	On the eAIP window, clicking on the organisation's logo in the Commands pane, shall open the organisations website in a separate window. Parent requirements: [eAIP-HIST-160]	C

2.5.7 AIP Tabbed Page

[eAIP-MENU-460]	On the eAIP window, in the bottom panel of the Commands pane, the title of the AIP tabbed page shall be "AIP"	M
[eAIP-MENU-470]	On the eAIP window, in the bottom panel of the Commands pane, the title of the AIP tabbed page shall be a link to the AIP Table of Contents.	M
[eAIP-MENU-480]	On the eAIP window, clicking on the title of the AIP tabbed page in the bottom panel of the Commands pane shall open the AIP Table of content in the Navigation pane below.	M
[eAIP-MENU-490]	On the eAIP window, in the bottom panel of the Commands pane, the AIP tab shall have a grey (RGB Hexadecimal Value: cfcfdf) background when unselected.	M
[eAIP-MENU-500]	On the eAIP window, in the bottom panel of the Commands pane, the AIP tabbed page shall have a white (RGB Hexadecimal Value: ffffff) background when selected.	M
[eAIP-MENU-510]	On the eAIP, in the bottom panel of the Commands pane, the title of the AIP tabbed page shall be black (RGB Hexadecimal Value:000000) when the	M

	page is selected.	
[eAIP-MENU-520]	On the eAIP, in the bottom panel of the Commands pane, the title of the AIP tabbed page shall be in a bold font style when the page is selected.	M
[eAIP-MENU-530]	On the eAIP window, in the bottom pane of the Commands pane, the title of the AIP tabbed page shall be light blue (RGB Hexadecimal Value: 0000ff) and a bold font style when the page is unselected and has previously been opened in the current session.	M
[eAIP-MENU-540]	On the eAIP window in the bottom panel of the Commands pane, when the AIP tab is selected, it shall have the appearance of being on top of the other tabbed pages.	M

2.5.8 AMDT Tabbed Page

[eAIP-MENU-550]	On the eAIP window, in the bottom panel of the Commands pane, the title of the AMDT tabbed page shall be "AMDT".	M
[eAIP-MENU-560]	On the eAIP window, in the bottom of the Commands pane, the title of the AMDT tabbed page shall be a link to the AMDT "Table of Contents".	M
[eAIP-MENU-570]	On the eAIP window, clicking on the title of the AMDT tabbed page in the bottom panel of the Commands pane shall open the AMDT "Table of Contents" in the Navigation pane below.	M
[eAIP-MENU-580]	On the eAIP window, in the bottom panel of the Commands pane, the AMDT tab shall have a grey (RGB Hexadecimal Value: cfcfdf) background when it is unselected.	
[eAIP-MENU-590]	On the eAIP window, in the bottom panel of the Commands pane the AMDT tab shall have a white (RGB Hexadecimal Value: ffffff) background when it is selected.	M

[eAIP-MENU-600]	On the eAIP window, in the bottom panel of the Commands pane, the title of the AMDT tabbed page shall be black (RGB Hexadecimal Value:000000) and in a bold font style when the page is selected.	M
[eAIP-MENU-610]	On the eAIP window, in the bottom panel of the Commands pane, the title of the AMDT tabbed page text shall be dark blue (RGB Hexadecimal Value: 00008b) and in bold font style when the page is unselected and has not been previously opened in the current session.	M
[eAIP-MENU-620]	On the eAIP window, in the bottom panel of the Commands pane, the title of the AMDT tabbed page shall be light blue (RGB Hexadecimal Value: 0000ff) and in a bold font style when the page is unselected and has previously been opened in the current session.	M
[eAIP-MENU-630]	On the eAIP window, in the bottom panel of the Commands pane, when the AMDT tab is selected, it shall have the appearance of being on top of the other tabbed pages.	M

2.5.9 SUPs Tabbed Page

[eAIP-MENU-640]	On the eAIP window, in the bottom panel of the Commands pane, the title of the AIP SUPs tabbed page shall be "SUPs".	M
[eAIP-MENU-650]	On the eAIP window, in the bottom panel of the Commands pane, the title of the SUPs tabbed page shall be a link to the SUPs "table of Contents".	M
[eAIP-MENU-660]	On the eAIP window, clicking on the title of the SUPS tabbed page in the bottom panel of the Commands pane shall open the SUPs "Table of Contents" in the Navigation pane below. Note: See Figure 12: SUPs "Table of Contents".	M
[eAIP-MENU-670]	On the eAIP window, in the bottom panel of the Commands pane, the SUPs tabbed page shall	M

	have a grey (RGB Hexadecimal Value: cfcfdf) background when it is unselected.	
[eAIP-MENU-680]	On the eAIP window, in the bottom panel of the Commands pane, the SUPs tabbed page shall have a white (RGB Hexadecimal Value: ffffff) background when it is selected.	M
[eAIP-MENU-690]	On the eAIP window, in the bottom panel of the Commands pane, the title of the SUPs tabbed page shall be black (RGB Hexadecimal Value: 000000) and in a bold font style when the page is selected.	M
[eAIP-MENU-700]	On the eAIP window, in the bottom panel of the Commands pane, the title of the SUPs tabbed page shall be dark blue (RGB Hexadecimal Value:00008b) and in bold font style when the page is unselected and has not previously been opened in the current session.	M
[eAIP-MENU-710]	On the eAIP window, in the bottom panel of the Commands pane, the title of the SUPs tabbed page shall be light blue (RGB Hexadecimal Value: 0000ff) and in a bold font style when the page is unselected and has previously been opened in the current session.	M
[eAIP-MENU-720]	On the eAIP window, in the bottom panel of the Commands pane, when the SUPs tab is selected, it shall have the appearance of being on top of the other tabbed pages.	M

2.5.10 AICs Tabbed Page

[eAIP-MENU-730]	On the eAIP window, in the bottom panel of the Commands pane, the title of the AICs tabbed page shall be "AICs"	M
[eAIP-MENU-740]	On the eAIP window, in the bottom panel of the Commands pane, the title of the AICs tabbed page shall be a link to the AICs "Table of Contents".	M
[eAIP-MENU-750]	On the eAIP window, clicking on the title of the AICs	M

	<p>tabbed page in the bottom panel of the Commands pane, shall open the AICs "Table of Contents" in the Navigation pane below.</p> <p>Note: See Figure 13: AIC Table of Contents</p>	
[eAIP-MENU-760]	On the eAIP window, in the bottom panel of the Commands pane, the AICs tabbed page shall have a grey (RGB Hexadecimal Value: cfcfdf) background when it is unselected.	M
[eAIP-MENU-770]	On the eAIP window, in the bottom panel of the commands pane, the AICs tabbed page shall have a white (RGB Hexadecimal Value: ffffff) background when it is selected.	M
[eAIP-MENU-780]	On the eAIP window, in the bottom panel of the Commands pane, the title of the AICs tabbed page shall be black (RGB Hexadecimal Value: 000000) and in a bold font style when the page is selected.	M
[eAIP-MENU-790]	On the eAIP window, in the bottom panel of the Commands pane, the title of the AICs tabbed page shall be dark blue (RGB Hexadecimal Value: 00008b) and in bold font style when the page is unselected and has not previously been opened in the current session.	M
[eAIP-MENU-800]	On the eAIP window, in the bottom panel of the Commands pane, the title of the AICs tabbed page shall be light blue (RGB Hexadecimal Value: 0000ff) and in a bold font style when the page is unselected and has previously been opened in the current session.	M
[eAIP-MENU-810]	On the eAIP window, in the bottom panel of the Commands pane, when the AIC tab is selected it shall have the appearance of being on top of the other tabbed pages.	M

2.5.11 Search Tabbed Page

[eAIP-MENU-820]	On the eAIP window, in the bottom panel of the Commands pane, the title of the Search tabbed page shall be "Search". Parent requirement: [eAIP-MENU-230]	C
[eAIP-MENU-830]	On the eAIP window, in the bottom panel of the Commands pane, the title of the Search tabbed page shall be a link to the Search facility. Parent requirement: [eAIP-MENU-230]	C
[eAIP-MENU-840]	On the eAIP window, clicking on the Search tabbed page in the bottom panel of the Commands pane shall open the Search facility in the Navigation pane below. Parent requirement: [eAIP-MENU-230]	C
[eAIP-MENU-850]	On the eAIP window, in the bottom panel of the Commands pane, the Search tabbed page shall have a grey (RGB Hexadecimal Value: cfcfdf) background when unselected. Parent requirement: [eAIP-MENU-230]	C
[eAIP-MENU-860]	On the AIP window, in the bottom panel of the Commands pane, the Search tabbed page shall have a white (RGB Hexadecimal Value: ffffff) background when it is selected. Parent requirement: [eAIP-MENU-230]	C
[eAIP-MENU-870]	On the eAIP window, in the bottom panel of the Commands pane, the title of the Search tabbed page shall be black (RGB Hexadecimal Value: 000000) and in a bold font style when the page is selected. Parent requirement: [eAIP-MENU-230]	C
[eAIP-MENU-880]	On the eAIP window, in the bottom panel of the Commands pane, the title of the Search tabbed page shall be dark blue (RGB Hexadecimal Value:00008b) and in a bold font style when the page is unselected and has not previously been opened in the current session.	C

	Parent requirement: [eAIP-MENU-230]	
[eAIP-MENU-890]	On the eAIP window, in the bottom panel of the Commands pane, the title of the Search tabbed page shall be light blue (RGB Hexadecimal Value: 0000ff) and in a bold font style when the page is unselected and has previously been opened in the current session. Parent requirement: [eAIP-MENU-230]	C
[eAIP-MENU-900]	On the eAIP window, in the bottom panel of the Commands pane, when the Search tab is selected, it shall have the appearance being on the top of the other tabbed pages. Parent requirement: [eAIP-MENU-230]	C

2.6 eAIP Table of Contents

The figure below expresses the requirements associated with the display of AIP table of contents:

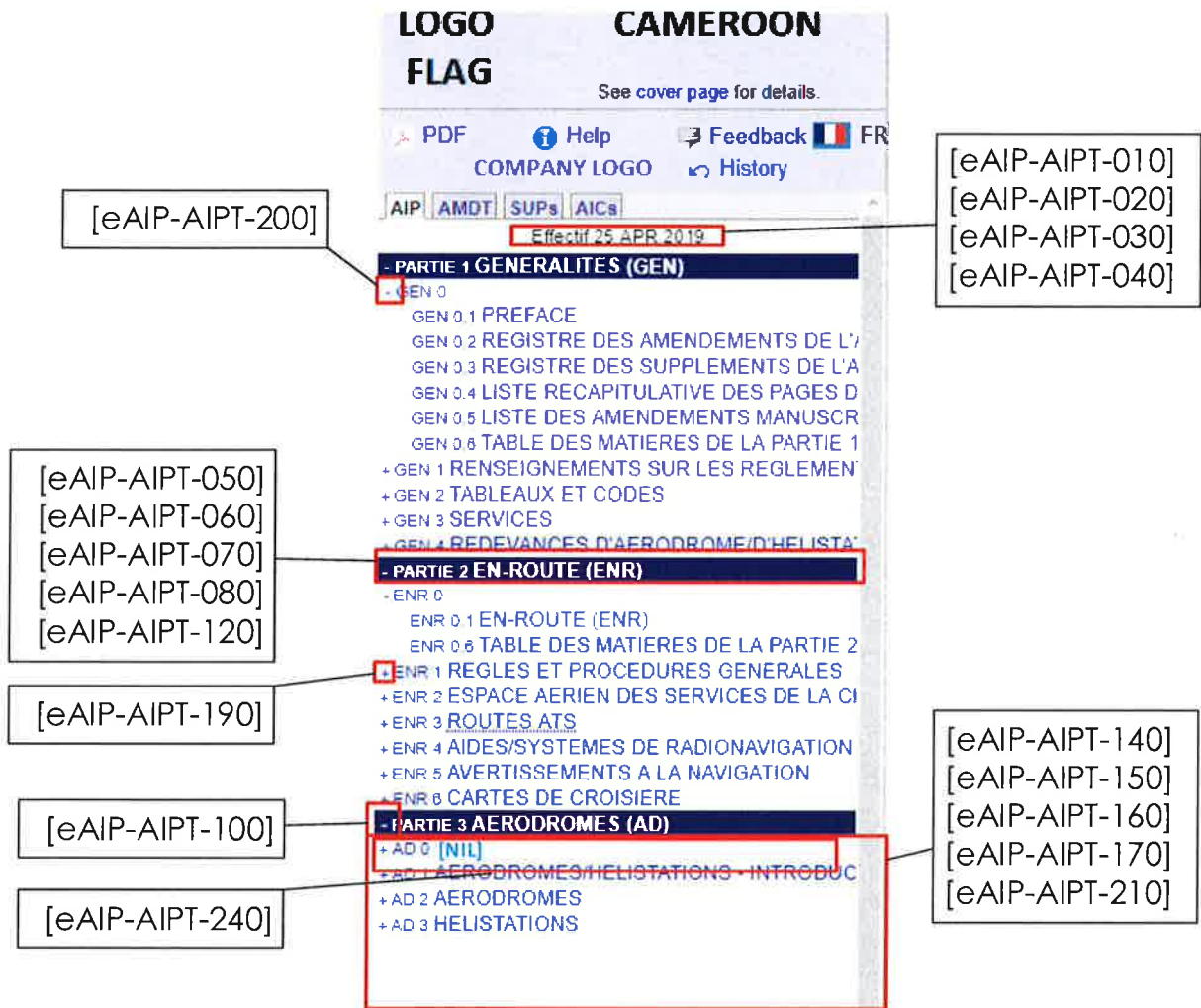

Figure 10: AIP Table of content

[eAIP-AIPT-010]	In the Navigation pane of the eAIP window, the AIP Table of Contents shall indicate the effective date of the AIP.	M
[eAIP-AIPT-020]	In the Navigation pane of the eAIP window, the effective date of the AIP in the AIP Table of Contents shall be black (RGB Hexadecimal Value: 000000).	M
[eAIP-AIPT-030]	In the Navigation pane of the eAIP window, the effective date of the AIP in the AIP Table of Contents shall be in a bold font style.	M
[eAIP-AIPT-040]	In the Navigation pane of the eAIP window, the font size of the effective date of the AIP in the AIP Table of Contents shall be 150% of the default font size.	M
[eAIP-AIPT-050]	In the Navigation pane of the eAIP window, the three parts of the AIP in the AIP Table of Contents shall be highlighted with dark blue headers (RGB	M

	Hexadecimal Value: 00008b).	
[eAIP-AIPT-060]	In the Navigation pane of the eAIP window, in the AIP Table of Contents, the title of the AIP part shall be white (RGB Hexadecimal Value: ffffff).	M
[eAIP-AIPT-070]	In the Navigation pane of the eAIP window, in the AIP Table of Contents, the title of the AIP part shall contain the part number.	M
[eAIP-AIPT-080]	In the Navigation pane of the eAIP window, in the AIP Table of Contents, the title of the AIP part shall also contain the name of the part, as given in the eAIP itself, in a bold font style.	M
[eAIP-AIPT-090]	In the Navigation pane of the eAIP window, in the AIP Table of Contents, by default, the AIP part shall be expanded when the AIP Table of Contents is opened.	M
[eAIP-AIPT-100]	In the Navigation pane of the eAIP window, in the AIP Table of Contents, the part title shall have a minus sign ("-") next to it when expanded to allow for the AIP Table of Contents tree to be collapsed.	M
[eAIP-AIPT-110]	In the Navigation pane of the eAIP window, in the AIP Table of Contents, the part title shall have a plus sign ("+") next to it when collapsed to allow for the AIP Table of Contents tree to be expanded.	M
[eAIP-AIPT-120]	In the Navigation pane of the eAIP window, in the AIP Table of Contents, the title of the part shall be a link.	M
[eAIP-AIPT-130]	In the Navigation pane of the eAIP window, in the AIP Table of Contents, clicking on the title of the part shall open section 0 of the clicked part in the Content pane of the eAIP window.	M
[eAIP-AIPT-140]	In the Navigation pane of the eAIP window, in the AIP Table of Contents, for each part, the Table of Contents shall list each chapter in the part.	M
[eAIP-AIPT-150]	In the Navigation pane of the eAIP window, in the AIP Table of Contents, the title of the chapter shall	M

	be preceded by the name of the part.	
[eAIP-AIPT-160]	In the Navigation pane of the eAIP window, in the AIP Table of Contents, the number of the chapter shall be included in the title of the chapter.	M
[eAIP-AIPT-170]	In the Navigation pane of the eAIP window, in the AIP Table of Contents, the title of the chapter shall include a description of its contents, as laid out in ICAO Annex 15[RD 1] and in ICAO Doc 8126[RD 2].	M
[eAIP-AIPT-180]	In the Navigation pane of the eAIP window, in the AIP Table of Contents, the chapters shall be collapsed in the AIP Table of Contents tree, by default.	
[eAIP-AIPT-190]	In the Navigation pane of the eAIP window, in the AIP Table of Contents, the chapter title shall have a plus sign (“+”) next to it when collapsed to allow for the AIP Table of Contents tree to be expanded.	M
[eAIP-AIPT-200]	In the Navigation pane of the eAIP window, in the AIP Table of Contents, the chapter title shall have a minus sign (“-”) next to it when expanded to allow for the AIP Table of Content tree to be collapsed.	M
[eAIP-AIPT-210]	In the Navigation pane of the eAIP window, in the AIP Table of Contents, the title of the chapter shall be a link.	M
[eAIP-AIPT-220]	In the Navigation pane of the eAIP window, in the AIP Table of Contents, clicking on the title of the chapter shall open the chapter in the content pane of the eAIP window.	M
[eAIP-AIPT-230]	In the Navigation pane of the eAIP window, in the AIP Table of Contents, clicking on a collapsed part or chapter shall expand the part, or chapter.	M
[eAIP-AIPT-240]	In the Navigation pane of the eAIP window, in the AIP Table of Contents, the title of any NIL section shall be preceded by “[NIL]”.	M
[eAIP-AIPT-250]	When navigating the eAIP, all sections without any content shall display in the Content pane an empty	M

DM
MM

	page with the word "NIL".	
[eAIP-AIPT-260]	When a NIL section is selected, the eAIP page displayed in the Content pane of the eAIP window may contain additional supporting text.	M
[eAIP-AIPT-270]	The PDF format of a NIL section shall be available from the PDF link in the Commands pane, as for all other sections.	M

2.7 AMDT Table of Contents

The figure below expresses the requirements associated with the display of the AMDT Table of Contents.

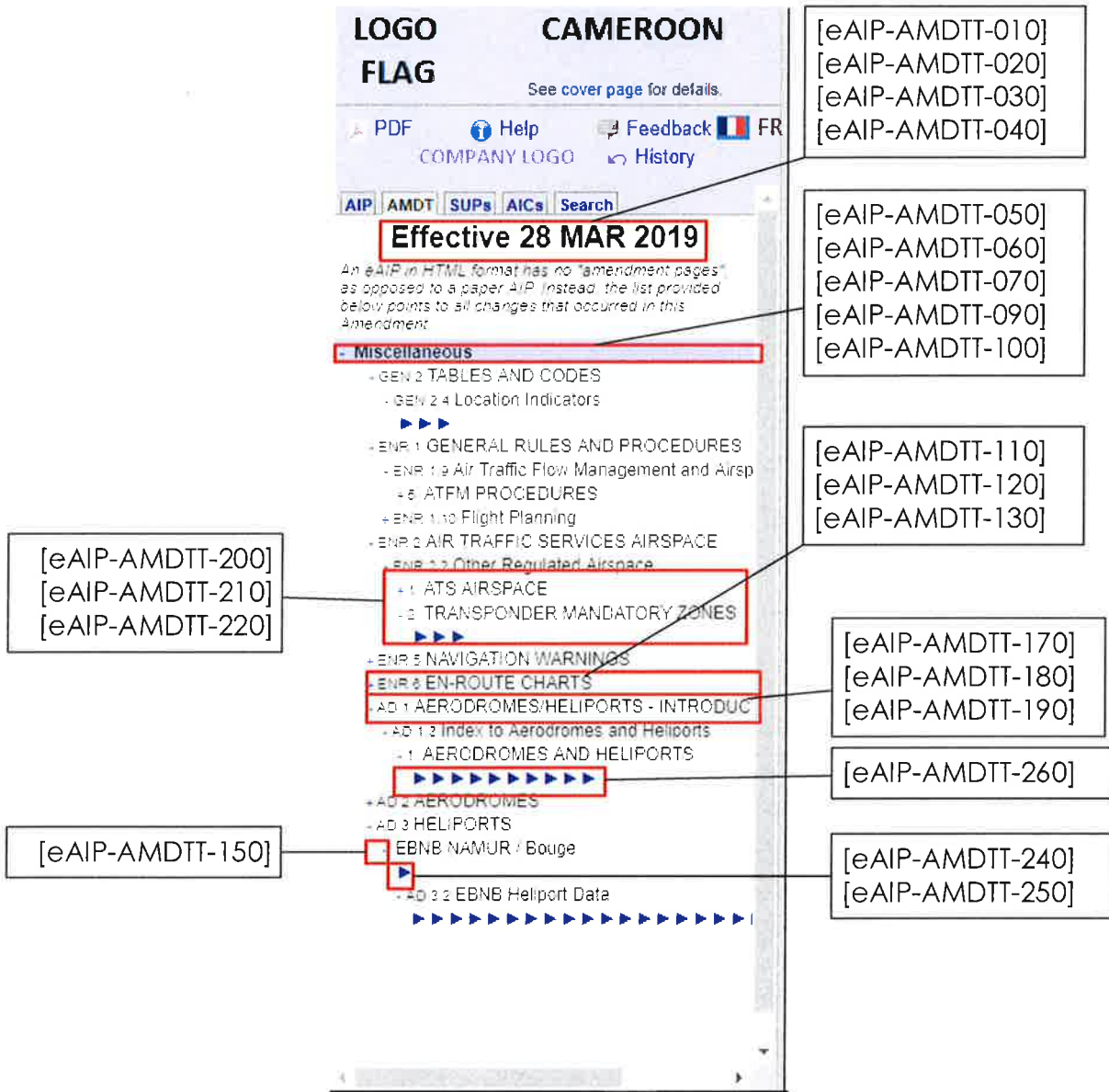

Figure 11: AMDT "Table of Contents"

[eAIP-AMDTT-010]	In the Navigation Pane of the eAIP window, the AMDT "Table of Contents" shall indicate the effective date of the eAIP AMDT.	M
[eAIP-AMDTT-020]	In the Navigation Pane of the eAIP window, in the AMDT "Table of Contents", the effective date shall be black (RGB Hexadecimal Value: 000000).	M
[eAIP-AMDTT-030]	In the Navigation Pane of the eAIP window, the effective date of the AMDT in the AMDT "Table of Contents" shall be a bold font style.	M
[eAIP-AMDTT-040]	In the Navigation Pane of the eAIP window, the	M

	font size of the effective date of the AMDT in the AMDT "Table of Contents" shall be 150% of the default size.	
[eAIP-AMDTT-050]	In the Navigation Pane of the eAIP window, in the AMDT "Table of Contents", the changes forming an AMDT shall be grouped so that they are logically related and are presented under a single group.	M
[eAIP-AMDTT-060]	In the Navigation Pane of the eAIP window, in the AMDT "Table of Contents", for each group, a group title shall be displayed.	M
[eAIP-AMDTT-070]	In the Navigation Pane of the eAIP window, in the AMDT "Table of Contents", the title of the group shall be black (RGB Hexadecimal Value: 000000).	M
[eAIP-AMDTT-080]	In the Navigation Pane of the eAIP window, in the AMDT "Table of Contents", if the AMDT is an AIRAC AMDT then the background colour of the group title shall be pink (RGB Hexadecimal Value: ffcccc).	M
[eAIP-AMDTT-090]	In the Navigation Pane of the eAIP window, in the AMDT "Table of Contents", if the AMDT is a non-AIRAC AMDT then the colour of the title shall be light blue (RGB Hexadecimal Value: ccccff).	M
[eAIP-AMDTT-100]	In the Navigation Pane of the eAIP window, the AMDT "Table of Contents" shall contain a description for each group of AIP AMDTs.	M
[eAIP-AMDTT-110]	In the Navigation Pane of the eAIP window, the AMDT "Table of Contents", shall contain the chapter number of the AIP where the amendment(s) has been made, for each group of AIP AMDTs.	M
[eAIP-AMDTT-120]	In the Navigation Pane of the eAIP window, the AMDT "Table of Contents" shall contain the title of the affected chapter for each group of AIP AMDTs.	M

[eAIP-AMDTT-130]	In the Navigation Pane of the eAIP window, in the AMDT "Table of Contents", the chapter shall have a plus sign ('+') next to it when collapsed to allow for the AMDT "Table of Contents" tree to be expanded.	M
[eAIP-AMDTT-140]	In the Navigation Pane of the eAIP window, in the AMDT "Table of Contents", the chapter shall be expanded by clicking on the chapter title.	M
[eAIP-AMDTT-150]	In the Navigation Pane of the eAIP window, in the AMDT "Table of Contents", the chapter shall have a minus sign ('-') next to it when expanded to allow the AMDT "Table of Contents" tree to be collapsed.	M
[eAIP-AMDTT-160]	In the Navigation Pane of the eAIP window, in the AMDT "Table of Contents", the chapter shall be collapsed by clicking on the chapter title.	M
[eAIP-AMDTT-170]	In the Navigation Pane of the eAIP window, in the AMDT "Table of Contents", when the chapter is expanded, sections of the chapter containing amendments shall be listed.	M
[eAIP-AMDTT-180]	In the Navigation Pane of the eAIP window, in the AMDT "Table of Contents", the title of the section of the chapter containing amendments shall include the section name.	M
[eAIP-AMDTT-190]	In the Navigation Pane of the eAIP window, in the AMDT "Table of Contents", the title of the section of the chapter containing amendments shall include a section name.	M
[eAIP-AMDTT-200]	In the Navigation Pane of the eAIP window, in the AMDT "Table of Contents", for each section of the chapter containing amendments, the amendments shall be listed.	M
[eAIP-AMDTT-210]	In the Navigation Pane of the eAIP window, in the AMDT "Table of Contents", amendments shall be grouped by the nearest sub-section title.	M
[eAIP-AMDTT-220]	In the Navigation Pane of the eAIP window, in	M

	the AMDT "Table of Contents", the nearest sub-section title shall be listed.	
[eAIP-AMDTT-230]	In the Navigation Pane of the eAIP window, in the AMDT "Table of Contents", the number of the nearest sub-section title may be listed.	O
[eAIP-AMDTT-240]	In the Navigation Pane of the eAIP window, in the AMDT "Table of Contents", each individual change in an amendment group shall be indicated by a light blue triangle (RGB Hexadecimal Value: 0000ff)	M
[eAIP-AMDTT-250]	In the Navigation Pane of the eAIP window, in the AMDT "Table of Contents", the triangle for an individual change in an amendment group shall be a link to the change.	M
[eAIP-AMDTT-260]	In the Navigation Pane of the eAIP window, in the AMDT "Table of Contents", the triangles shall be located next to the parent sub-section title.	M
[eAIP-AMDTT-270]	In the Navigation Pane of the eAIP window, in the AMDT "Table of Content", when a change is selected, the change shall be displayed at the top of the Content pane of the eAIP.	M

2.8 SUPS Table of Contents

The figure below shows the requirements associated with the display of the SUPs Table of Content.

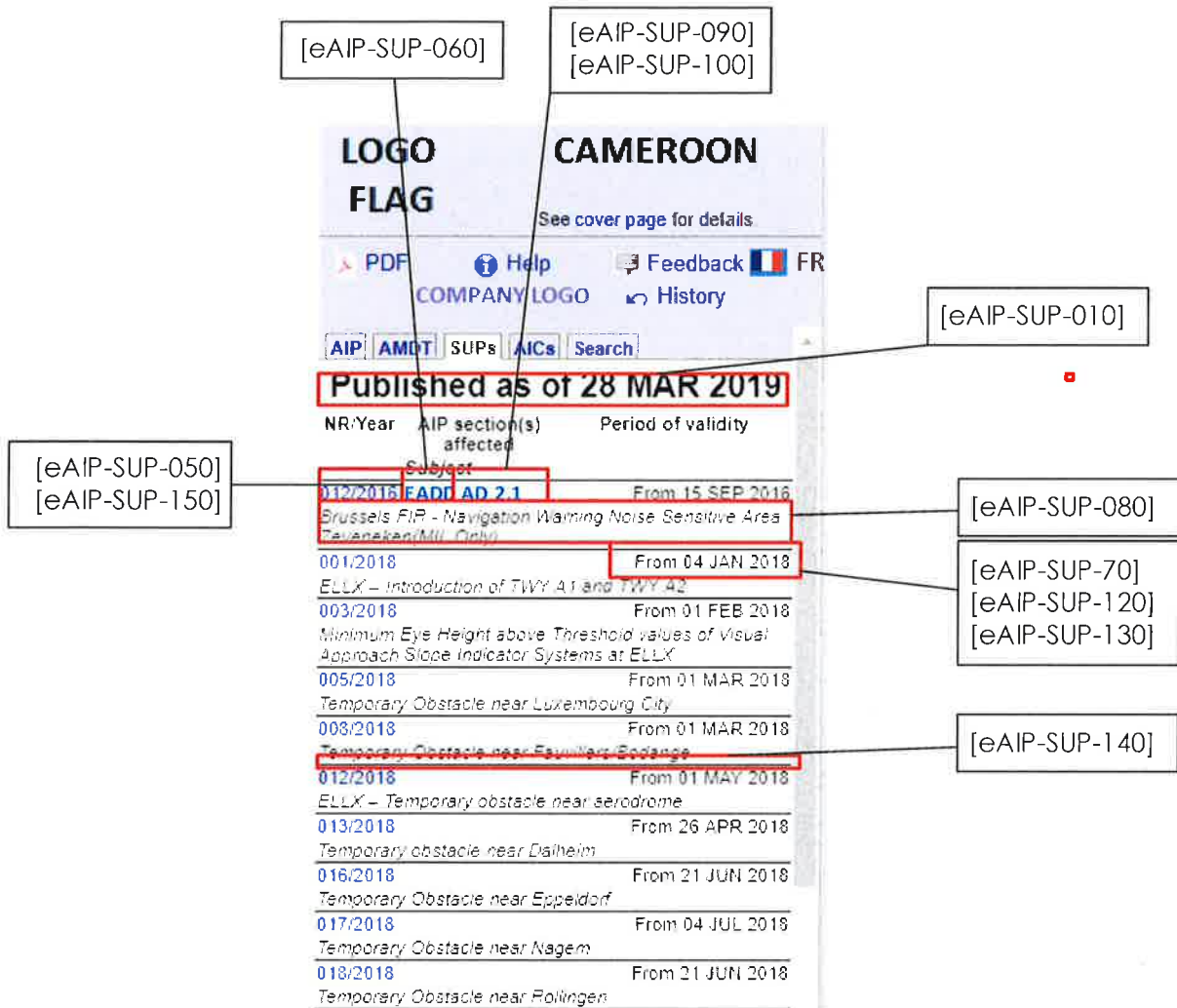

Figure 12: SUPs "Table of Contents"

[eAIP-SUPT-010]	In the Navigation pane of the eAIP window, the SUPs "Table of Contents" shall indicate the date the SUPs "Table of Contents" page was published.	M
[eAIP-SUPT-020]	In the Navigation pane of the eAIP window, in the SUPs "Table of Contents", the date the SUPs "Table of Contents" page was published shall be black (RGB Hexadecimal Value: 000000).	M
[eAIP-SUPT-030]	In the Navigation pane of the eAIP window, the publication date of the SUPs "Table of Contents" page shall be in a bold font style.	M
[eAIP-SUPT-040]	In the Navigation pane of the eAIP window, the font size of the publication date of the SUPs "Table of Contents" page shall be 150% of the default font size.	M
[eAIP-SUPT-050]	In the Navigation pane of the eAIP window, in the	M

Handwritten signature

	SUPs Table of Contents", for each SUP, the Number/Year of the SUP shall be listed.	
[eAIP-SUPT-060]	In the Navigation pane of the eAIP window, in the SUPs Table of Contents", for each SUP, the AIP section(s) affected by the SUP shall be listed.	M
[eAIP-SUPT-070]	In the Navigation pane of the eAIP window, in the SUPs Table of Contents", for each SUP, the period of validity of the SUP shall be listed.	M
[eAIP-SUPT-080]	In the Navigation pane of the eAIP window, in the SUPs Table of Contents", for each SUP, the subject of the SUP shall be listed.	M
[eAIP-SUPT-090]	In the Navigation pane of the eAIP window, in the SUPs Table of Contents", the AIP section(s) affected shall be indicated by the part plus the section.	M
[eAIP-SUPT-100]	In the Navigation pane of the eAIP window, in the SUPs Table of Contents", the AIP section(s) affected shall be a link to the actual section in the eAIP.	M
[eAIP-SUPT-110]	In the Navigation pane of the eAIP window, when the AIP section affected link is clicked in the SUPs "Table of Contents", the eAIP section shall open in the Content pane of the active window.	M
[eAIP-SUPT-120]	In the Navigation pane of the eAIP window, in the SUPs Table of Contents", the period of validity shall indicate from which date the SUP is valid.	M
[eAIP-SUPT-130]	In the Navigation pane of the eAIP window, in the SUPs Table of Contents", the period of validity may indicate the date for the end of the validity period.	O
[eAIP-SUPT-140]	In the Navigation pane of the eAIP window, in the SUPs Table of Contents", SUPs should be clearly separated in the list.	O
[eAIP-SUPT-150]	In the Navigation pane of the eAIP window, in the SUPs Table of Contents", the Number/Year of the AIP SUP shall be a link.	M
[eAIP-SUPT-160]	In the Navigation pane of the eAIP window, when the SUP link is clicked in the SUPs "Table of Contents",	M

	the SUP shall open in the Content pane of the active window.	
[eAIP-SUPT-170]	The links between the list of SUPs and AIP sections affected shall be controlled and updated so that the SUP published in the past always links to the latest published (or effective) eAIP issue Parent requirement: [eAIP-SUPT-100]	C

2.9 AIC Table of Contents

The figure below reflects the requirements associated with the display of the AIC Table of Contents.

The screenshot shows the 'CAMEROON' AIC Table of Contents page. The page header includes 'LOGO FLAG', 'See cover page for details', and navigation links for PDF, Help, Feedback, and History. The main content is a table with columns for 'NR/Year', 'Published on', and 'Series'. A red box highlights the text 'Published as of 28 MAR 2019' at the top of the table. Several rows in the table are also highlighted with red boxes, and callout boxes point to these elements with specific requirement IDs.

NR/Year	Published on	Series
-	No Series	-
002/2009	04 JUN 2009	-
<i>Carriage and Operation of SSR Mode S Airborne Equipment and ACAS II - Exemption Arrangements</i>		
007/2010	16 DEC 2010	-
<i>Slot Notification for General Aviation in FPL</i>		
005/2012	28 JUN 2012	-
<i>Validation of Licenses (Information at the request of the Civil Aviation Authority)</i>		
013/2012	18 OCT 2012	-
<i>Track-keeping on Departure from and Arrival to Brussels National Airport (Information at the request of the Civil Aviation Authority)</i>		
001/2014	09 JAN 2014	-
<i>Airspace Infringement due to Altimeter Settings</i>		
004/2014	03 APR 2014	-
<i>Trial Implementation of RLatSM in the ICAO Nat Region</i>		
006/2014	29 MAY 2014	-
<i>ICAO 24-bit Aircraft Addresses and Aircraft Identification Reporting</i>		
007/2014	29 MAY 2014	-
<i> Holders of a Flight Crew License (Information at the request of the Civil Aviation Authority)</i>		
010/2014	21 AUG 2014	-
<i>Volcanic Ash</i>		

Callout boxes and their associated requirement IDs:

- [eAIP-AICT-050] [eAIP-AICT-070] points to the 'Published as of 28 MAR 2019' text.
- [eAIP-AICT-010] [eAIP-AICT-020] [eAIP-AICT-030] [eAIP-AICT-040] points to the 'Published as of 28 MAR 2019' text.
- [eAIP-AICT-060] points to the 'No Series' text in the first row.
- [eAIP-AICT-080] [eAIP-AICT-130] points to the '005/2012' text in the row for 'Validation of Licenses'.
- [eAIP-AICT-110] points to the '013/2012' text in the row for 'Track-keeping on Departure from and Arrival to Brussels National Airport'.
- [eAIP-AICT-120] points to the '001/2014' text in the row for 'Airspace Infringement due to Altimeter Settings'.

Figure 13: AIC Table of Contents

[eAIP-AICT-010]	In the Navigation pane of the eAIP window, the AICs "Table of Contents" shall indicate the date on which the AICs "Table of Contents" page was published.	M
-----------------	---	---

[eAIP-AICT-020]	In the Navigation pane of the eAIP window, in the AICs "Table of Contents", the date on which the AICs "Table of Contents" page was published shall be black (RGB Hexadecimal Value: 000000).	M
[eAIP-AICT-030]	In the Navigation pane of the eAIP window, the publication date of the AIC "Table of Contents" page shall be in bold font style.	M
[eAIP-AICT-040]	In the Navigation pane of the eAIP window, the publication date of the AIC "Table of Contents" page shall be 150% of the default font size.	M
[eAIP-AICT-050]	In the Navigation pane of the eAIP window, the AICs may be grouped by series.	O
[eAIP-AICT-060]	In the Navigation pane of the eAIP window, the AICs grouped by series may be expanded to show all the AICs in a series. Parent requirement: [eAIP-AICT-050]	C
[eAIP-AICT-070]	In the Navigation pane of the eAIP window, the AICs grouped by series may be collapsed to hide all the AICs in a series. Parent requirement: [eAIP-AICT-050]	C
[eAIP-AICT-080]	In the Navigation pane of the eAIP window, in the AICs "Table of Contents", for each AIC, the Number/Year of the AIC shall be listed.	M
[eAIP-AICT-090]	In the Navigation pane of the eAIP window, in the AICs "Table of Contents", for each AIC, the date of the publication of the AIC shall be listed.	M
[eAIP-AICT-100]	In the Navigation pane of the eAIP window, in the AICs "Table of Contents", for each AIC that is grouped by series, the series shall be listed.	M
[eAIP-AICT-110]	In the Navigation pane of the eAIP window, in the AICs "Table of Contents", for each AIC, the subject shall be listed.	M
[eAIP-AICT-120]	In the Navigation pane of the eAIP window, in the AICs "Table of Contents", each AIC should be clearly	O

	separated in the list.	
[eAIP-AICT-130]	In the Navigation pane of the eAIP window, in the AICs "Table of Contents", the Number/Year of the AIC shall be a link.	M
[eAIP-AICT-140]	In the Navigation pane of the eAIP window, in the AICs "Table of Contents", when the Number/Year of The AIC is clicked, the AIC shall open in the Content pane of the active window.	M

2.10 Help Page

[eAIP-HELP-010]	The Help page shall contain information about the eAIP being published by the State.	M
[eAIP-HELP-020]	The Help page shall contain information regarding the system requirements of the eAIP.	M
[eAIP-HELP-030]	The Help page shall contain information regarding the use of the menu.	M
[eAIP-HELP-040]	The Help page shall contain information regarding the use of the AIP tab.	M
[eAIP-HELP-050]	The Help page shall contain information regarding the use of the AMDT tab.	M
[eAIP-HELP-060]	The Help page shall contain information regarding the use of the AIC tab.	M
[eAIP-HELP-070]	The Help page shall contain information regarding the use of SUP tab.	M
[eAIP-HELP-080]	The Help page shall contain information regarding the viewing of Amendments.	M
[eAIP-HELP-090]	The Help page shall contain information regarding the use of the search facility.	M
[eAIP-HELP-100]	The Help page shall contain information regarding the use of the formats used for charts and graphics, and tools that can be used to visualise each of these formats.	M

[eAIP-HELP-110]	The Help page may contain information regarding other features of the eAIP.	○
[eAIP-HELP-120]	The Help page may contain a frequently asked questions section.	○
[eAIP-HELP-130]	The Help page may contain additional information regarded as useful for the consultation and use of the eAIP.	○

2.11 AIP Content

2.11.1 Initial display

The figure below expresses the requirements associated with the initial display of the eAIP content.

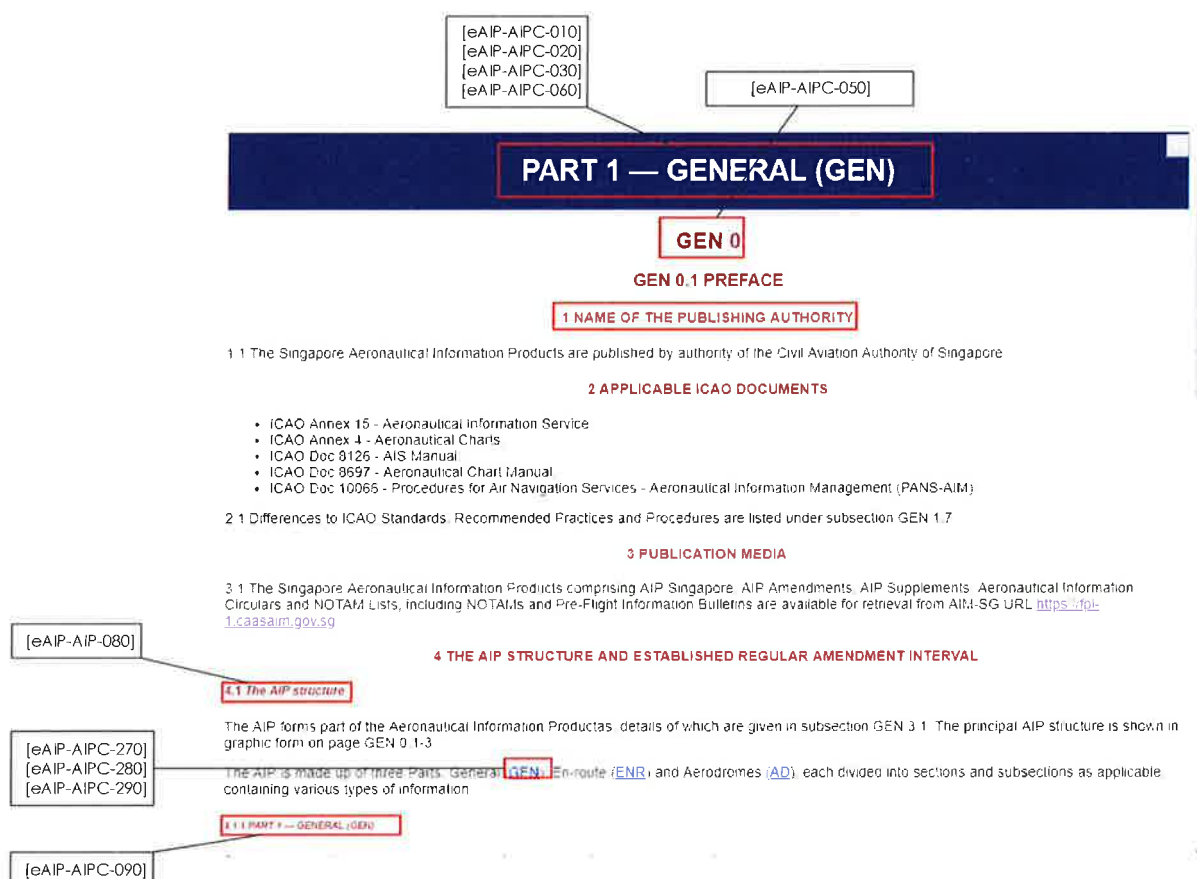

Figure 14: eAIP Content

[eAIP-AIPC-010]	When an AIP is displayed, the title of the AIP part or section selected shall be displayed at the top of the Content pane of the eAIP window.	M
-----------------	---	---

[eAIP-AIPC-020]	When an AIP is displayed, the AIP part title should be displayed in a dark blue (RGB Hexadecimal Value: 00008b) header.	O
[eAIP-AIPC-030]	When an AIP is displayed, the AIP part title shall be white (RGB Hexadecimal Value: ffffff).	M
[eAIP-AIPC-040]	When AIP is displayed, all other titles in the AIP should be brown (RGB Hexadecimal Value: 800000).	O
[eAIP-AIPC-050]	When an AIP is displayed, the titles of the AIP parts and sections shall be in upper case.	M
[eAIP-AIPC-060]	When AIP is displayed, the font size of the AIP part titles shall be larger than that for AIP section titles.	M
[eAIP-AIPC-070]	When an AIP is displayed, level 1 AIP sub-sections shall have titles in upper case.	M
[eAIP-AIPC-080]	When an AIP is displayed, level 2 AIP sub-sections shall have titles in mixed case and in a bold font style.	M
[eAIP-AIPC-090]	When an AIP is displayed, all other AIP titles shall be in mixed case.	M

2.11.2 GEN 0.2 – Record of AIP Amendments

The figure below represents the requirements associated with the display of GEN 0.2 of the AIP.

GEN 0

**GEN 0.2 REGISTRE DES AMENDEMENTS DE L'AIP
RECORD OF AIP AMENDMENTS**

AMENDEMENT AIP		
NR/Year	Date de publication	Date d'insertion
03/15	22 JAN 2015	05 FEB 2015
04/15	19 FEB 2015	05 MAR 2015
05/15	19 MAR 2015	02 APR 2015
06/15	16 APR 2015	30 APR 2015
07/15	14 MAY 2015	28 MAY 2015
08/15	11 JUN 2015	25 JUN 2015
09/15	09 JUL 2015	23 JUL 2015
10/15	06 AUG 2015	20 AUG 2015
11/15	03 SEP 2015	17 SEP 2015
12/15	01 OCT 2015	15 OCT 2015
13/15	29 OCT 2015	12 NOV 2015
01/16	26 NOV 2015	10 DEC 2015

AMENDEMENT AIRAC AIP		
NR/Year	Date de publication	Date d'entrée en vigueur
06/18	12 APR 2018	24 MAY 2018
07/18	10 MAY 2018	21 JUN 2018
08/18	07 JUN 2018	19 JUL 2018
09/18	05 JUL 2018	16 AUG 2018
10/18	02 AUG 2018	13 SEP 2018
11/18	30 AUG 2018	11 OCT 2018
12/18	27 SEP 2018	08 NOV 2018
13/18	25 OCT 2018	06 DEC 2018
01/19	22 NOV 2018	03 JAN 2019
02/19	20 DEC 2018	31 JAN 2019
03/19	17 JAN 2019	28 FEB 2019
04/19	14 FEB 2019	28 MAR 2019

Figure 15: GEN 0.2

[eAIP-AIPC-100]	In the AIP, GEN 0.2 Record of AIP Amendments page shall include two tables for both the AIRAC amendments and non-AIRAC amendments.	M
[eAIP-AIPC-110]	The GEN 0.2 Record of AIP Amendments of the AIP, for both AIRAC amendments and non-AIRAC amendments, the Number/Year shall be provided.	M
[eAIP-AIPC-120]	In GEN 0.2 Record of AIP Amendments of the AIP for both the AIRAC amendments and the non-AIRAC amendments, the Publication Date shall be provided.	M
[eAIP-AIPC-130]	In GEN 0.2 Record of AIP Amendments of the AIP, for the AIRAC amendments, the Effective Date shall be provided.	M
[eAIP-AIPC-140]	In the PDF file for the GEN 0.2 Record of the AIP	M

	Amendments, the page shall include a column for the signature of the person that inserted the AIP Amendment, for both the AIRAC and non-AIRAC amendments.	
--	---	--

2.11.3 GEN 1.7 – Differences from ICAO Standards, Recommended Practices and Procedures.

[eAIP-AIPC-150]	Data published in the eAIP that does not meet the data quality requirements of ICAO Annex 15[RD 1] should be listed in GEN 1.7 "Differences from ICAO Standards, Recommended Practices and Procedures"	M
[eAIP-AIPC-160]	Data published in the eAIP that does not meet the data quality requirements of Arrête N° 001303/MINT [RD 5] should be listed in GEN 1.7 "Differences from ICAO Standards, Recommended Practices and Procedures"	M

2.11.4 GEN 2.2 – Abbreviations used in AIS Publications

The figure below reflects the requirement associated with the display of abbreviations in Gen 2.2 of the AIP.

MP

GEN 2.2 ABBREVIATIONS UTILISEES DANS LES PUBLICATIONS AIS
ABBREVIATIONS USED IN AIS PUBLICATIONS

A- ABCDEFGHIJKLMNOPQRSTUVWXYZ

[eAIP-AIPC-180]

La présente liste groupe l'ensemble des abréviations utilisées dans les publications françaises d'information aéronautique, avec leurs définitions et leurs traductions en anglais
 This list contains all the abbreviations used in the French aeronautical information publication with their meaning and English translation

A	Ambre	Amber
A/A	Radiocommunications Air/Air	Air to air communications
AAL	Au-dessus du niveau de l'aérodrome	Above aerodrome level
ABM	Par le travers de	Abeam
ABN	Phare d'aérodrome	Aerodrome beacon
ABV	Au-dessus (de) ou supérieur (à)	Above or upper
ACARS	Système embarqué de communications, d'adressage et de compte rendu	Aircraft communication addressing and reporting system
ACAS	Système embarqué d'anti-abordage	Airborne collision avoidance system
ACB	Aéro-club	Flying club
ACC	Centre de contrôle régional ou contrôle régional	Area control centre or area control
ACFT	Aéronef	Aircraft
ACL	Emplacement destiné à la vérification des altimètres	Altimeter check location
ACN	Numéro de classification d'avion	Aircraft classification number
ACP	Message d'acceptation	Acceptance message
ACPT	Accepté ou accepté	Accept or accepted
ACT	En service ou en activité ou activité	Active or activated or activity
AD	Aérodrome	Aerodrome
ADAC	Avion à décollage et atterrissage court	Short take off and landing aircraft
ADAV	Avion à décollage et atterrissage vertical	Vertical take off and landing aircraft
ADC	Carte d'aérodrome	Aerodrome chart
ADDN	Addition ou supplémentaire	Addition or additional
ADF	Radio compas automatique	Automatic direction finder
ADJ	Adjacent	Adjacent
ADP	Aéroports de Paris	Aéroports de Paris
ADS	Adresse	Address
Aé	Faisceau de phare marin relevé de 10° au dessus de l'horizon en vue de son utilisation par les navigateurs aériens	Marine light beacon with beam angle 10° above the horizon for use by airmen
AEM	Aéromodélisme	Model aircraft flight

[eAIP-AIPC-160]

Figure 16: Abbreviations of GEN 2.2

[eAIP-AIPC-170]	Abbreviations used in AIS publications should be listed in ascending alphabetic order.	○
[eAIP-AIPC-180]	A fast access bar may be used to access abbreviations.	○

2.11.5 AD 2.24 Titles of charts

[eAIP-AIPC-190]	In AD 2.24 of the AIP, the titles of the charts related to an aerodrome should be listed in a table.	○
-----------------	--	---

2.11.6 Structure of the AIP

[eAIP-AIPC-200]	In the AIP, sections may be added to chapters of the AIP to reflect any new publication requirements of the State.	○
[eAIP-AIPC-210]	Where the tables in the AIP Template provided in Appendix 2 of ICAO PANS AIM DOC 10066 [RD 3] may not be implemented electronically to allow the presentation of information to the user in a clear and	○

	user-friendly manner, the information may be presented in the AIP in a different structure that follows the ICAO structure as closely as possible.	
--	--	--

2.11.7 Content Abbreviations

[eAIP-AIPC-220]	Abbreviations may be underlined in the text of the AIP by a dash line.	O
[eAIP-AIPC-230]	When the cursor is placed over an underlined abbreviation in the AIP, a hint shall be displayed providing the full definition of the abbreviation. Parent requirement: [eAIP-AIPC-220].	C
[eAIP-AIPC-240]	When the cursor is placed over an underlined abbreviation in the AIP, a question mark may appear on the cursor. Parent requirement: [eAIP-AIPC-220]	C

2.11.8 AIP Content Links

[eAIP-AIPC-250]	In the main body of the AIP, displayed in the Content pane, where other sections of the AIP are referred to, a link should be provided to that section.	O
[eAIP-AIPC-260]	In the main body of the AIP, displayed in the Content pane, the links to other sections of the AIP shall be highlighted in light blue (RGB Hexadecimal Value: 0000ff). Parent requirement: [eAIP-AIPC-250].	C
[eAIP-AIPC-270]	In the main body of the AIP, displayed in the Content pane, the links to other sections of the AIP shall be underlined. Parent requirement: [eAIP-AIPC-250].	C
[eAIP-AIPC-280]	In the main body of the AIP, displayed in the Content pane, when a link to another section of the AIP is clicked, the appropriate section of the AIP shall open in the Content pane of the eAIP window.	C

	Parent requirement: [eAIP-AIPC-250].	
--	--------------------------------------	--

2.11.9 AIP Content Amendments

The figure below represents the requirements associated with the display of the AIP content amendments.

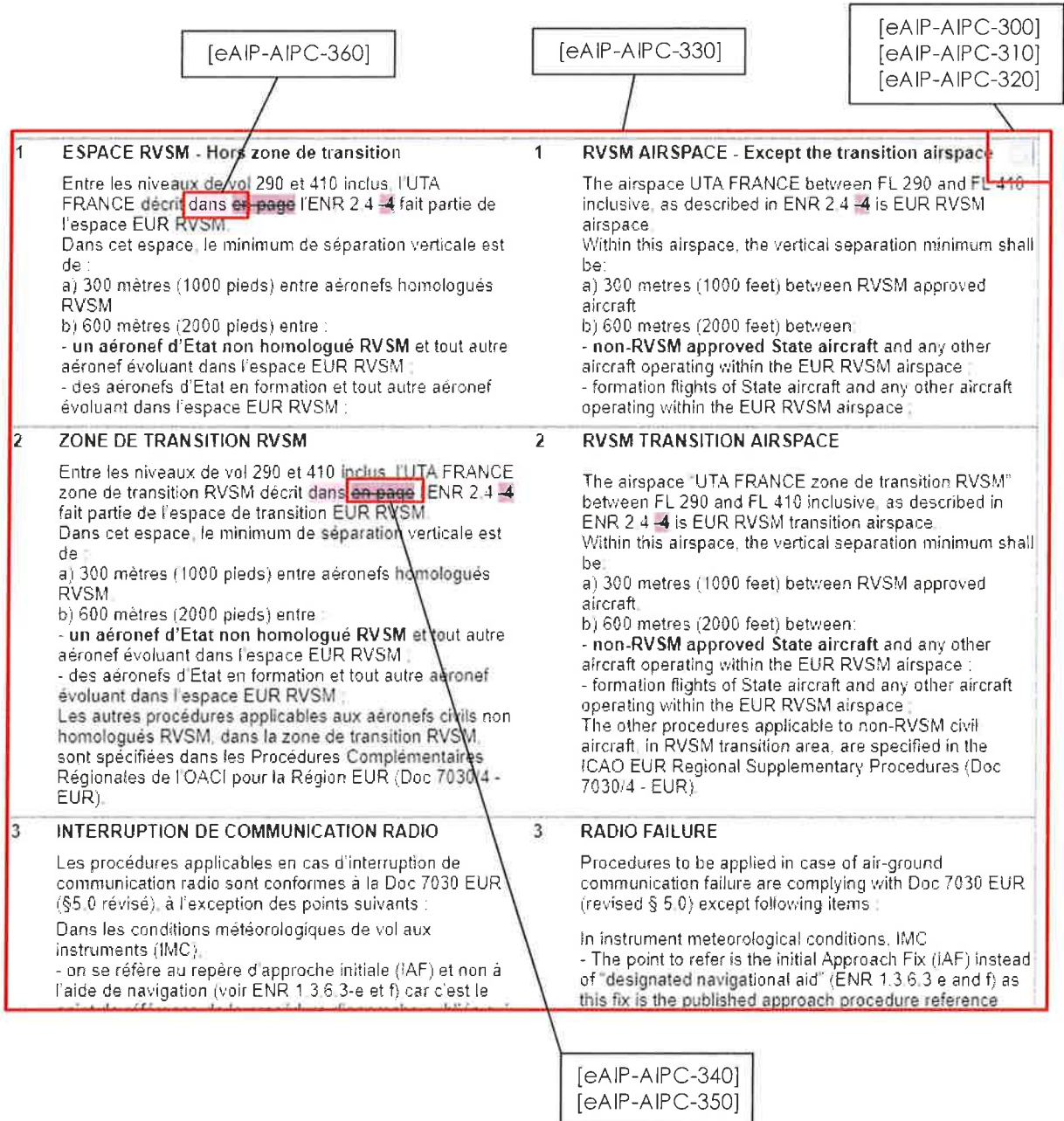

Figure 17: AIP Content Amendments

[eAIP-AIPC-290]	The user shall be able to see amendments within the body of the AIP text.	M
[eAIP-AIPC-300]	When an AIP is selected, there shall be a tick box in the top right corner of the Content pane of the eAIP window to allow the user to choose whether to show	M

	amendments within the body of the AIP text.	
[eAIP-AIPC-310]	When an AIP is selected, there shall be a tick box in the top right corner of the Content pane of the eAIP window, which allows the user to choose whether to show amendments within the body of the AIP text, shall be titled "Show Amendments".	M
[eAIP-AIPC-320]	When an AIP is selected, a tick box in the top right corner of the Content pane of the eAIP window shall enable a user to select to show or hide amendments within the body of the AIP text.	M
[eAIP-AIPC-330]	When an AIP is selected, when the "Show Amendments" tick box in the top right corner of the Content pane of the eAIP window is checked, all deleted and added text shall be displayed.	M
[eAIP-AIPC-340]	When an AIP is selected, deleted AIP text shall be displayed as struck through when the "Show amendments" tick box in the top right corner of the Content pane of the eAIP window is checked.	M
[eAIP-AIPC-350]	When an AIP is selected, when the "Show Amendments" tick box in the top right corner of the Content pane of the eAIP window is checked, if the amendment to the AIP was notified by an AIRAC AMDT, deleted text shall be highlighted with a dark pink (RGB Hexadecimal Value: cc9999) background.	M
[eAIP-AIPC-360]	When an AIP is selected, when the "Show Amendments" tick box in the top right corner of the Content pane of the eAIP window is checked, if the amendment to the AIP was notified by an AIRAC AMDT, added text shall be highlighted with a light pink (RGB Hexadecimal Value: ffcccc) background.	M
[eAIP-AIPC-370]	When an AIP is selected, when the "Show Amendments" tick box in the top right corner of the Content pane of the eAIP window is checked, if the amendment to the AIP was notified by a non-AIRAC AMDT, deleted text shall be highlighted with a dark blue (RGB Hexadecimal Value: 9999cc)	M

	background.	
[eAIP-AIPC-380]	When an AIP is selected, when the "Show Amendments" tick box in the top right corner of the Content pane of the eAIP window is checked, if the amendment to the AIP was notified by a non-AIRAC AMDT, added text shall be highlighted with a light blue (RGB Hexadecimal Value: ccccff) background.	M
[eAIP-AIPC-390]	When an AIP is selected, when the "Show Amendments" tick box in the top right corner of the Content pane of the eAIP window is checked, changed to the numbering of the AIP should be displayed.	O

2.12 AMDT Content

The figure below shows the requirements associated with the display of the AMDT content.

The screenshot shows a document with the following content:

[eAIP-AMDT-030]
[eAIP-AMDT-060]

A valid International Certificate of Vaccination for yellow fever is required from travellers above one year of age who have been in or have passed through any country with risk of yellow fever transmission in the six days before arriving in Singapore. The certificate is valid for life, beginning from 10 days after the date of vaccination (this applies to existing and new certificates). An exemption letter, signed by a medical practitioner, is required for individuals who are exempted from being vaccinated before entry into Singapore. Please refer to Singapore's Immigration & Checkpoints Authority website for the updated list of countries with risk of yellow fever transmission.

~~a. Smallpox and cholera vaccination certificates are not required.~~
b. A yellow fever vaccination certificate is required from travellers above one year of age who, within the preceding six days, have been in or have passed through any country partly or wholly endemic for yellow fever. The certificate is valid for a period of 10 years, beginning ten days after the date of vaccination or in the event of a re-vaccination within such period of ten years, from the date of that re-vaccination.

4 FLYING LICENCES AND RATINGS

4.1 VISITING PILOTS - HOLDERS OF NON-SINGAPORE PILOT LICENCES

4.1.1 When a holder of a non-Singapore pilot's licence wishes to fly on a Singapore registered aircraft in a private capacity in Singapore, he will be required to apply for a Certificate of Validation for his foreign licence. The Certificate of Validation, if approved, will be issued for this purpose only and for a limited period. The applicant would also be required to fulfil certain conditions. Pilots who wish to apply for a Certificate of Validation should contact the Personnel Licensing Section of the Civil Aviation Authority of Singapore (see address in paragraph 4.2.2 below).

4.2 CONVERSION OF FOREIGN LICENCE TO SINGAPORE LICENCE

4.2.1 Pilots holding valid licences, including an instrument rating and/or flying instructor's rating issued by ICAO Contracting States, may be considered for the conversion of their licences under the following conditions:

- (a) The pilot must demonstrate formal prospective employment by a Singapore air operator, approved training organisation or flying club to operate on Singapore registered aircraft. (This requirement will not be applicable for the conversion of a foreign licence to a Singapore PPL.)
- (b) The pilot's foreign licence and its associated ratings must be valid from the time of application to the time of issue of a Singapore licence and its associated ratings.
- (c) The pilot must fulfil all conversion terms as specified by CAAS within a period of 6 months preceding the issue of a Singapore licence and its associated ratings.

4.2.2 Further details on the conversion of a foreign licence can be obtained from:

Safety Policy and ~~Planning~~ Licensing Division
Personnel Licensing Section
Civil Aviation Authority of Singapore
Singapore Changi Airport Terminal 2
South Finger Pier Level 3
Unit No. 038-039
Singapore 819643

[eAIP-AMDT-070]

Figure 18: AMDT Content

Handwritten signature/initials in blue ink.

[eAIP-AMDTC-010]	When a change in an AMDT has been selected in the AMDT "Table of Contents", the content displayed in the Content pane of the eAIP window shall be the AIP page where the change has been made.	M
[eAIP-AMDTC-020]	When a change in an AMDT has been selected in the AMDT "Table of Contents", the specific change selected shall be highlighted by red (RGB Hexadecimal Value: ff0000) border in the Content pane of the eAIP window.	M
[eAIP-AMDTC-030]	When a textual change in an AMDT has been selected in the AMDT "Table of Contents", deleted text shall be struck through in the Content pane of the eAIP window.	M
[eAIP-AMDTC-040]	When a change to an image/graphic in an AMDT has been selected in the AMDT "Table of Contents", then the change should be identified directly in the graphic/image by way of a textual description along the side of the graphic/image.	O
[eAIP-AMDTC-050]	When a change to an image/graphic file in an AMDT has been selected in the AMDT "Table of Contents", then the whole image or graphic should be marked as deleted and the new image/graphic should be marked as inserted.	O
[eAIP-AMDTC-060]	When a change in an AMDT has been selected in the AMDT "Table of Contents", if the AMDT is an AIRAC AMDT, deleted text shall have a dark pink (RGB Hexadecimal Value: cc9999) background, in the Content pane of the eAIP window.	M
[eAIP-AMDTC-070]	When a change in an AMDT has been selected in the AMDT "Table of Contents", if the AMDT is an AIRAC AMDT, added text shall have a light pink (RGB Hexadecimal Value: ffcccc) background, in the Content pane of the eAIP window.	M
[eAIP-AMDTC-080]	When a change in an AMDT has been selected	M

	in the AMDT "Table of Contents", if the AMDT is a non-AIRAC AMDT, added text shall have a dark blue (RGB Hexadecimal Value: 9999cc) background, in the Content pane of the eAIP window.	
[eAIP-AMDT-090]	When a change in the AMDT has been selected in the AMDT "Table of Contents", if the AMDT is a non-AIRAC AMDT, added text shall have a light blue (RGB Hexadecimal Value: ccccff) background, in the Content pane of the eAIP window.	M
[eAIP-AMDT-100]	When a change in an AMDT has been selected in the AMDT "Table of Contents", the amended text shall be displayed as high as possible in the Content pane.	M

2.13 SUP Content

The figure below reflects the requirements associated with the display of the SUP content.

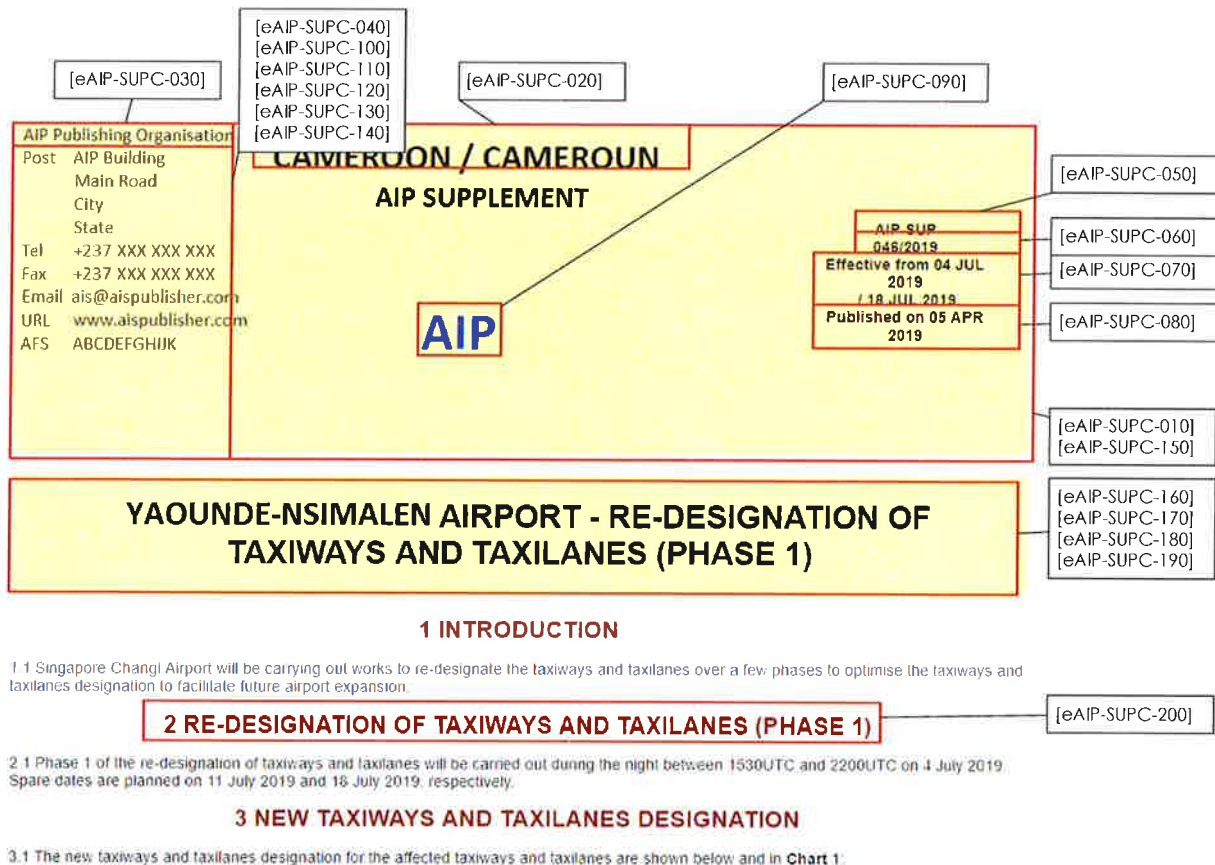

Figure 19: AIP SUP Content

[Handwritten signature]

[eAIP-SUPC-010]	When a SUP has been selected in the SUPs "Table of Contents", the SUP page displayed in the Content pane of the eAIP window should have a yellow (RGB Hexadecimal Value: ffff99) header.	O
[eAIP-SUPC-020]	When a SUP has been selected in the SUPs "Table of Contents", the SUP page displayed in the Content pane of the eAIP window shall have the name of the issuing State, in the header.	M
[eAIP-SUPC-030]	When a SUP has been selected in the SUPs "Table of Contents", the SUP page displayed in the Content pane of the eAIP window shall have the name of the publishing organisation in the header.	M
[eAIP-SUPC-040]	When a SUP has been selected in the SUPs "Table of Contents", the SUP page displayed in the Content pane of the eAIP window shall have the postal address of the publishing organisation in the header.	M
[eAIP-SUPC-050]	When a SUP has been selected in the SUPs "Table of Contents", the SUP page displayed in the Content pane shall have an indication that the document is a SUP in the header.	M
[eAIP-SUPC-060]	When a SUP has been selected in the SUPs "Table of Contents", the SUP page displayed in the Content pane of the eAIP window shall have the Number/Year of the SUP, in the header.	M
[eAIP-SUPC-070]	When a SUP has been selected in the SUPs "Table of Contents", the SUP page displayed in the Content pane of the eAIP window shall have the effective date of the SUP, in the header.	M
[eAIP-SUPC-080]	When a SUP has been selected in the SUPs "Table of Contents", the SUP page displayed in the Content pane of the eAIP window shall have the publication date of the SUP, in the header.	M
[eAIP-SUPC-090]	When a SUP has been selected in the SUPs "Table of Contents", the SUP page displayed in the Content pane of the eAIP window may have the logo of the publishing organisation in the header.	O

[eAIP-SUPC-100]	When a SUP has been selected in the SUPs "Table of Contents", the SUP page displayed in the Content pane of the eAIP window may have the telephone number of the publishing organisation in the header.	O
[eAIP-SUPC-110]	When a SUP has been selected in the SUPs "Table of Contents", the SUP page displayed in the Content pane of the eAIP window may have the fax number of the publishing organisation, in the header.	O
[eAIP-SUPC-120]	When a SUP has been selected in the SUPs "Table of Contents", the SUP page displayed in the Content pane of the eAIP window may have the email address of the publishing organisation, in the header.	O
[eAIP-SUPC-130]	When a SUP has been selected in the SUPs "Table of Contents", the SUP page displayed in the Content pane of the eAIP window may have the website address of the publishing organisation, in the header.	O
[eAIP-SUPC-140]	When a SUP has been selected in the SUPs "Table of Contents", the SUP page displayed in the Content pane of the eAIP window may have the address of the Aeronautical Fixed Service (AFS) of the publishing organisation, in the header.	O
[eAIP-SUPC-150]	When a SUP has been selected in the SUPs "Table of Contents", the text in the header of the SUP page displayed in the Content pane of the eAIP window shall be black (RGB Hexadecimal Value: 000000).	M
[eAIP-SUPC-160]	When a SUP has been selected in the SUPs "Table of Contents", the SUP page displayed in the Content pane of the eAIP window shall have a header containing the subject of the SUP.	M
[eAIP-SUPC-170]	When a SUP has been selected in the SUPs "Table of Contents", the subject header of the SUP page displayed in the Content pane of the eAIP window should be yellow (RGB Hexadecimal Value: ffff99).	O
[eAIP-SUPC-180]	When a SUP has been selected in the SUPs "Table of Contents", the text of the subject header of the SUP	M

	page displayed in the Content pane of the eAIP window shall be black (RGB Hexadecimal Value: 000000).	
[eAIP-SUPC-190]	When a SUP has been selected in the SUPs "Table of Contents", the text of the subject header of the SUP page displayed in the Content pane of the eAIP window shall be upper case.	M
[eAIP-SUPC-200]	When a SUP has been selected in the SUPs "Table of Contents", the text of the sub-headings on the SUP page displayed in the Content pane of the eAIP window, should be brown (RGB Hexadecimal Value: 800000)	O
[eAIP-SUPC-210]	Where a SUP is replacing a previously issued SUP, deleted SUP text may be displayed as struck through.	O
[eAIP-SUPC-220]	Where a SUP is replacing a previously issued SUP, and the SUP is an AIRAC SUP, deleted text may be highlighted with a dark pink (RGB Hexadecimal Value: cc9999) background.	O
[eAIP-SUPC-230]	Where a SUP is replacing a previously issued SUP, and the SUP is an AIRAC SUP, added text may be highlighted with a light pink (RGB Hexadecimal Value: ffcccc).	O
[eAIP-SUPC-240]	Where a SUP is replacing a previously issued SUP, and the SUP is a non-AIRAC SUP, the deleted text may be highlighted with a dark blue (RGB Hexadecimal Value: 9999cc) background.	O
[eAIP-SUPC-250]	Where a SUP is replacing a previously issued SUP, and the SUP is a non-AIRAC SUP, the added text may be highlighted with light blue (RGB Hexadecimal Value: ccccff) background.	O

2.14 AIC Content

The figure below reflects the requirements associated with the display of the content

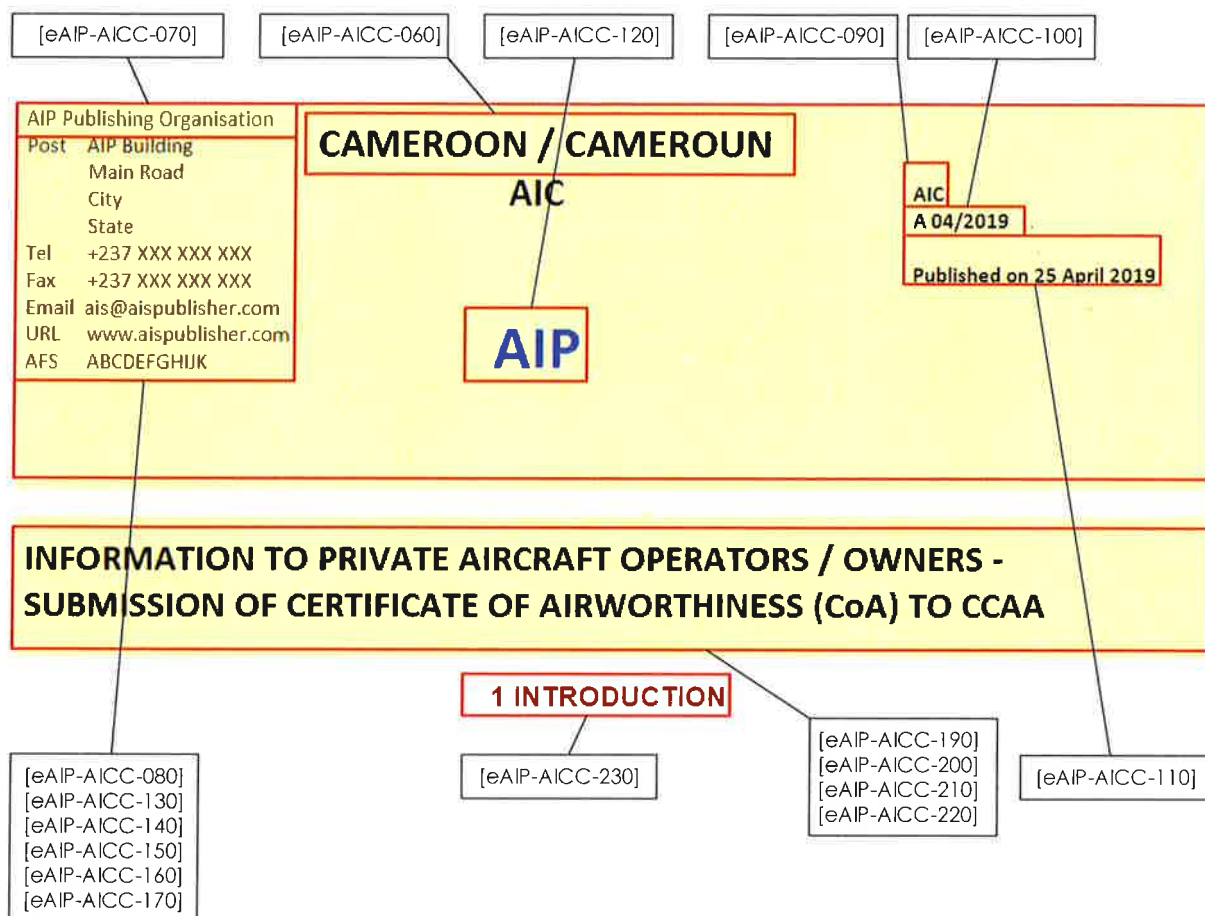

Figure 20: AIC Content

[eAIP-AICC-010]	When the AIC with an administrative-related subject has been selected in the AICs "Table of Contents", the AIC page displayed in the Content pane of the eAIP window should not have a coloured header.	○
[eAIP-AICC-020]	When an AIC with an Air Traffic Control-related subject has been selected in the AICs "Table of Contents", the AIC page displayed in the Content pane of the eAIP window should have a yellow (RGB Hexadecimal Value: ffff99) header.	○
[eAIP-AICC-030]	When an AIC with a safety-related subject has been selected in the AICs "Table of Contents", the AIC page displayed in the Content pane of the eAIP window should have a pink (RGB Hexadecimal Value: ffcccc) header.	○
[eAIP-AICC-040]	When an AIC containing a Danger Area Map has been selected in the AICs "Table of Contents", the AIC page displayed in the Content pane of the eAIP window should have a mauve (RGB Hexadecimal	○

MP

	Value: ccaaff) header.	
[eAIP-AICC-050]	When an AIC containing maps/charts has been selected in the AIC "Table of Contents", the AIC page displayed in the Content pane of the eAIP window should have a green (RGB Hexadecimal Value: 99cc99) header.	O
[eAIP-AICC-060]	When an AIC has been selected in the AICs "Table of Contents", the AIC page displayed in the Content pane of the eAIP window shall have the name of the issuing State of the AIC, in the header.	M
[eAIP-AICC-070]	When an AIC has been selected in the AICs "Table of Contents", the AIC page displayed in the Content pane of the eAIP window shall have the name of the publishing organisation of the AIC, in the header.	M
[eAIP-AICC-080]	When an AIC has been selected in the AICs "Table of Contents", the AIC page displayed in the Content pane of the eAIP window shall have the postal address of publishing organisation of the AIC, in the header.	M
[eAIP-AICC-090]	When an AIC has been selected in the AICs "Table of Contents", the AIC page displayed in the Content pane of the eAIP window shall have an indication that this document is an AIC, in the header.	M
[eAIP-AICC-100]	When an AIC has been selected in the AICs "Table of Contents", the AIC page displayed in the Content pane of the eAIP window shall have the Number/Year of the AIC, in the header.	M
[eAIP-AICC-110]	When an AIC has been selected in the AICs "Table of Contents", the AIC page displayed in the Content pane of the eAIP window shall have the publication date of the AIC, in the header.	M
[eAIP-AICC-120]	When an AIC has been selected in the AICs "Table of Contents", the AIC page displayed in the Content pane of the eAIP window may have the logo of the publishing organisation, in the header.	O
[eAIP-AICC-130]	When an AIC has been selected in the AICs "Table	O

	of Contents", the AIC page displayed in the Content pane of the eAIP window may have the telephone number of the publishing organisation.	
[eAIP-AICC-140]	When an AIC has been selected in the AICs "Table of Contents", the AIC page displayed in the Content pane of the eAIP window may have the fax number of the publishing organisation, in the header.	O
[eAIP-AICC-150]	When an AIC has been selected in the AICs "Table of Contents", the AIC page displayed in the Content pane of the eAIP window may have the email of the publishing organisation, in the header.	O
[eAIP-AICC-160]	When an AIC has been selected in the AICs "Table of Contents", the AIC page displayed in the Content pane of the eAIP window may have the website address of the publishing organisation, in the header.	O
[eAIP-AICC-170]	When an AIC has been selected in the AICs "Table of Contents", the AIC page displayed in the Content pane of the eAIP window may have the address of the AFS, in the header.	O
[eAIP-AICC-180]	When an AIC has been selected in the AICs "Table of Contents", the text displayed in the AIC header in the Content pane of the eAIP window shall be black (RGB Hexadecimal Value: 000000).	M
[eAIP-AICC-190]	When an AIC has been selected in the AICs "Table of Contents", the AIC page displayed in the Content pane of the eAIP window shall have a header containing the subject of the AIC.	M
[eAIP-AICC-200]	When an AIC has been selected in the AICs "Table of Contents", the colour of the subject header of the AIC page displayed in the Content pane of the eAIP window should match the colour of the main AIC header. Parent requirement: [eAIP-AICC-010]- [eAIP-AICC-050].	C
[eAIP-AICC-210]	When an AIC has been selected in the AICs "Table of Contents", the text of the subject header of the	M

	AIC page displayed in the Content pane of the eAIP window shall be black (RGB Hexadecimal Value: 000000).	
[eAIP-AICC-220]	When the AIC has been selected in the AICs "Table of Contents", the text of the subject header of the AIC page displayed in the Content pane of the eAIP window shall be in upper case.	M
[eAIP-AICC-230]	When an AIC has been selected in the AICs "Table of Contents" the text of sub-headings on the AIC page displayed in the Content pane of the eAIP window, should be brown (RGB Hexadecimal Value: 800000).	O
[eAIP-AICC-240]	When an AIC is replacing a previously issued AIC, deleted text may be displayed as struck through.	O
[eAIP-AICC-250]	Where an AIC is replacing a previously issued AIC, deleted text may be highlighted with a dark blue (RGB Hexadecimal Value: 9999cc) background.	O
[eAIP-AICC-260]	Where an AIC is replacing a previously issued AIC, added text may be highlighted with a light blue (RGB Hexadecimal Value: ccccff) background.	O

2.15 Distribution via Physical Media

[eAIP-DIST-010]	If the physical media contains a new AIRAC AMDT and AIRAC SUP then it shall be distributed in accordance with the AIRAC cycle.	M
[eAIP-DIST-020]	When distributing an eAIP, the physical media shall be labelled with a unique identifier. Note: A unique identifier could be a unique number per published physical media e.g eAIP Nbr. 057 or a unique number per eAIP package e.g 09/2019.	M
[eAIP-DIST-030]	When distributing an eAIP, the physical media shall be labelled with the publication date of the eAIP.	M
[eAIP-DIST-040]	When distributing an eAIP, the physical media shall be labelled with the State which has issued the eAIP.	M

[eAIP-DIST-050]	When distributing an eAIP, the physical media shall be labelled with the organisation that has published the eAIP.	M
[eAIP-DIST-060]	When distributing and eAIP, the physical media shall be labelled with the contact details of the publishing organisation.	M

2.16 Minimum eAIP HTML Technology Requirements

[eAIP-TECH-010]	The version(s) of the HTML used by the eAIP shall be documented.	M
[eAIP-TECH-020]	If a scripting language is used for the eAIP, the language shall be documented.	M
[eAIP-TECH-030]	If a scripting language is used for the eAIP, the version shall be documented.	M
[eAIP-TECH-040]	The validator used for the eAIP validation should be documented. Note: Unicorn W3C Unified Validator or W3C Mark-up Validator are recommended.	O
[eAIP-TECH-050]	The browser(s) tested with the eAIP should be documented.	O
[eAIP-TECH-060]	The version(s) of the browser(s) tested with the eAIP should be documented.	O

2.17 Minimum eAIP PDF Technology Requirements

[eAIP-TECH-070]	The version of PDF reader used by the eAIP shall be documented.	M
[eAIP-TECH-080]	The PDF reader(s) tested with the eAIP should be documented.	O
[eAIP-TECH-090]	The version(s) of the PDF reader(s) tested with the eAIP should be documented.	O

3. APPENDIX 3: CONFORMITY MATERIAL

- (1) This section specifies the conformity assessment material available for the MoC specified in this CCAA eAIP specification, in part II.
- (2) Applicants claiming conformance to this CCAA eAIP Specification shall complete the Conformance statement below.
- (3) Note: In the following table, compliance is indicated in the Req column as "M" (Mandatory), "O" (Optional) or "C" (Conditional).

Identifier	Feature	Req	Dependency
[eAIP-AIPC-010]	Colour of eAIP text.	M	
[eAIP-AIPC-020]	Colour of unlinked text.	M	
[eAIP-AIPC-030]	Display of links.	M	
[eAIP-AIPC-040]	Date format.	M	
[eAIP-AIPC-050]	Window structure	M	
[eAIP-AIPC-060]	Content of the Commands pane	M	
[eAIP-AIPC-070]	Content of the Navigation pane.	M	
[eAIP-AIPC-080]	Content of the Content pane when eAIP is first opened	M	
[eAIP-AIPC-090]	Content of the Content pane when selection is made in Navigation pane.	M	
[eAIP-AIPC-100]	Sizing of the left-hand and right-hand window panes.	M	
[eAIP-AIPC-110]	Availability of scrollbars.	M	
[eAIP-AIPC-120]	Consistency of eAIP and paper AIP.	M	
[eAIP-AIPC-130]	Most current update cycles made publicly available via the eAIP.	M	
[eAIP-SRCH-010]	Platform-independent search	C	When [eAIP-

	facility		MENU-230] is implemented.
[eAIP-SRCH-020]	Search facility to be independent of distribution means.	C	When [eAIP-MENU-230] is implemented.
[eAIP-SRCH-030]	Access to Search facility in the Navigation pane.	C	When [eAIP-MENU-230] is implemented.
[eAIP-SRCH-040]	Inclusion of "Search for" edit box.	C	When [eAIP-MENU-230] is implemented.
[eAIP-SRCH-050]	Presence of Start button.	C	When [eAIP-MENU-230] is implemented.
[eAIP-SRCH-060]	Presence of Clear button.	C	When [eAIP-MENU-230] is implemented.
[eAIP-SRCH-070]	Search results displayed in Navigation pane.	C	When [eAIP-MENU-230] is implemented.
[eAIP-SRCH-080]	Entry for each section/sub-section containing queried sequence of characters found.	C	When [eAIP-MENU-230] is implemented.
[eAIP-SRCH-090]	Each entry in the Navigation pane is a link.	C	When [eAIP-MENU-230] is implemented.
[eAIP-SRCH-100]	Display of section found in Content pane.	C	When [eAIP-MENU-230] is implemented.
[eAIP-HIST-010]	Availability of History page	O	
[eAIP-HIST-020]	Title of History page.	C	When [eAIP-HIST-010] is implemented.

[eAIP-HIST-030]	Inclusion of State name.	C	When [eAIP-HIST-010] is implemented.
[eAIP-HIST-040]	Inclusion of publishing organisation logo.	C	When [eAIP-HIST-010] is implemented.
[eAIP-HIST-050]	NOTAM advisory message	C	When [eAIP-HIST-010] is implemented.
[eAIP-HIST-060]	Name of the responsible publishing organisation.	C	When [eAIP-HIST-010] is implemented.
[eAIP-HIST-070]	Inclusion of Currently Effective Issue section.	C	When [eAIP-HIST-010] is implemented.
[eAIP-HIST-080]	Inclusion of Next Issues section.	C	When [eAIP-HIST-010] is implemented.
[eAIP-HIST-090]	Inclusion of Expired Issues (Archives) section.	C	When [eAIP-HIST-010] is implemented.
[eAIP-HIST-100]	Inclusion of effective date for currently effective issue.	C	When [eAIP-HIST-010] is implemented.
[eAIP-HIST-110]	Inclusion of publication date for currently effective issue.	C	When [eAIP-HIST-010] is implemented.
[eAIP-HIST-120]	Inclusion of reason for change for currently effective issue	C	When [eAIP-HIST-010] is implemented.
[eAIP-HIST-130]	Date as a link-currently effective issue.	C	When [eAIP-HIST-010] is implemented.
[eAIP-HIST-140]	Link to eAIP with effective	C	When [eAIP-HIST-010] is

	date-currently effective issue.		implemented.
[eAIP-HIST-150]	eAIP opens in active window-currently effective issue.	C	When [eAIP-HIST-010] is implemented.
[eAIP-HIST-160]	Inclusion of effective date for next issues of eAIP.	C	When [eAIP-HIST-010] is implemented.
[eAIP-HIST-170]	Inclusion of publication date for next issues of eAIP.	C	When [eAIP-HIST-010] is implemented.
[eAIP-HIST-180]	Inclusion of reasons for change for next issues of eAIP.	C	When [eAIP-HIST-010] is implemented.
[eAIP-HIST-190]	Date as a link- next issues.	C	When [eAIP-HIST-010] is implemented.
[eAIP-HIST-200]	Link to eAIP with effective date-next issues.	C	When [eAIP-HIST-010] is implemented.
[eAIP-HIST-210]	eAIP opens in active window-next issues.	C	When [eAIP-HIST-010] is implemented.
[eAIP-HIST-220]	Inclusion of effective date for the expires issues of eAIP.	C	When [eAIP-HIST-010] is implemented.
[eAIP-HIST-230]	Inclusion of the publication date for the expired issues of eAIP.	C	When [eAIP-HIST-010] is implemented.
[eAIP-HIST-240]	Inclusion of reasons for change for the expired issues of eAIP.	C	When [eAIP-HIST-010] is implemented.
[eAIP-HIST-250]	Warning that expired issues are for information purposes and are not to be used operationally.	C	When [eAIP-HIST-010] is implemented.

[eAIP-HIST-260]	Record of recently expired issues.	C	When [eAIP-HIST-010] is implemented.
[eAIP-HIST-270]	Date as a link- expired issues.	C	When [eAIP-HIST-010] is implemented.
[eAIP-HIST-280]	Link to eAIP with the effective date – expired issues	C	When [eAIP-HIST-010] is implemented.
[eAIP-HIST-290]	eAIP opens in active window- expired issues.	C	When [eAIP-HIST-010] is implemented.
[eAIP-COV-010]	Header on cover page	M	
[eAIP-COV-020]	Title of header.	M	
[eAIP-COV-030]	Indication of State.	M	
[eAIP-COV-040]	Inclusion of logo of state publishing organisation.	O	
[eAIP-COV-050]	Inclusion of warning to consult NOTAM.	M	
[eAIP-COV-060]	Inclusion of name of publishing organisation in header.	M	
[eAIP-COV-070]	Information on the eAIP Package section.	O	
[eAIP-COV-080]	Description section.	O	
[eAIP-COV-090]	Changes in this issue section.	O	
[eAIP-COV-100]	NOTAM incorporated in this Amendment section.	O	
[eAIP-COV-110]	Cancelled / replaced AIP SUPs section.	O	
[eAIP-COV-120]	Cancelled / replaced AIP AIC section.	O	

[eAIP-COV-130]	Inclusion of Effective date of the eAIP- Information on this eAIP package section.	<input type="radio"/>	
[eAIP-COV-140]	Inclusion of publication date of the eAIP-Information on this eAIP package.	<input type="radio"/>	
[eAIP-COV-150]	Inclusion of AIRAC AIP Amendment number – Description section (AIRAC).	<input type="radio"/>	
[eAIP-COV-160]	Inclusion of AIP Amendment number – Description section (non-AIRAC).	<input type="radio"/>	
[eAIP-COV-170]	Inclusion of an entry for each active AIP SUP, with its number – Change in this issue section.	<input type="radio"/>	
[eAIP-COV-180]	Inclusion of headline for SUP in Changes in this issue section.	<input type="radio"/>	
[eAIP-COV-190]	Inclusion of entry for each active AIC in Changes in this Issue section.	<input type="radio"/>	
[eAIP-COV-200]	Inclusion of headline for AIC in Changes in this issue section.	<input type="radio"/>	
[eAIP-COV-210]	Listing of all PERM NOTAM incorporated in eAIP package.	<input type="radio"/>	
[eAIP-COV-220]	Inclusion of headline for PERM NOTAM in NOTAM incorporated in this amendment section.	<input type="radio"/>	
[eAIP-COV-230]	Listing of numbers of SUPS cancelled/ replaced.	<input type="radio"/>	
[eAIP-COV-240]	Inclusion of headline for SUPs cancelled/replaced.	<input type="radio"/>	

[eAIP-COV-250]	Listing of numbers of AIC cancelled/replaced.	O	
[eAIP-COV-260]	Inclusion of headline for AIC cancelled/replaced.	O	
[eAIP-MENU-010]	Location of menu.	M	
[eAIP-MENU-020]	Division of command pane into panels	M	
[eAIP-MENU-030]	Background colour of panels.	M	
[eAIP-MENU-040]	Inclusion of State national flag or logo of publishing organisation in top panel.	O	
[eAIP-MENU-050]	Inclusion of name of state in top panel.	M	
[eAIP-MENU-060]	Colour of text for name of state	M	
[eAIP-MENU-070]	Link to the eAIP cover page in top panel.	M	
[eAIP-MENU-080]	Link to the eAIP history page in the bottom panel.	C	When [eAIP-HIST-010] is implemented.
[eAIP-MENU-090]	Drop-down list of available eAIPs.	O	
[eAIP-MENU-100]	Opening of cover page when selecting eAIP.	C	When [eAIP-MENU-090] is implemented.
[eAIP-MENU-110]	Link to a Help facility in bottom panel.	M	
[eAIP-MENU-120]	eAIP in at least the English and French Languages	M	
[eAIP-MENU-130]	Availability in languages other than English and French.	O	

[eAIP-MENU-140]	Link for each other language the eAIP is provided in, in the bottom panel.	C	When [eAIP-MENU-130] is implemented.
[eAIP-MENU-150]	Link to the current section or document in PDF format in the bottom panel.	O	
[eAIP-MENU-160]	Link to the website of the publishing organisation in bottom panel.	O	
[eAIP-MENU-170]	Link to enable the user submit feedback on the eAIP in bottom panel.	O	
[eAIP-MENU-180]	Ability to provide feedback through direct email contact or through a feedback form.	C	When [eAIP-MENU-170] implemented.
[eAIP-MENU-190]	Existence of AIP tabbed page.	M	
[eAIP-MENU-200]	Existence of AMDT tabbed page.	M	
[eAIP-MENU-210]	Existence of SUPs tabbed page.	M	
[eAIP-MENU-220]	Existence of AICs tabbed page.	M	
[eAIP-MENU-230]	Existence of Search tabbed page.	O	
[eAIP-MENU-240]	Title of link to the eAIP history	C	When [eAIP-HIST-010] and [eAIP-MENU-080] are implemented.
[eAIP-MENU-250]	Icon for the link to the eAIP history.	C	When [eAIP-HIST-010] and [eAIP-MENU-080] are implemented.
[eAIP-MENU-260]	Open of the eAIP History	C	When [eAIP-HIST-010] and [eAIP-

	window by clicking link.		MENU-080] are implemented.
[eAIP-MENU-270]	Open of the eAIP History window by clicking icon.	C	When [eAIP-HIST-010] and [eAIP-MENU-080] are implemented.
[eAIP-MENU-280]	Title of the link to help.	M	
[eAIP-MENU-290]	Logo or image or icon for help.	M	
[eAIP-MENU-300]	Open of help window by clicking link.	M	
[eAIP-MENU-310]	Open of eAIP History window by clicking logo or image icon.	M	
[eAIP-MENU-320]	Title as abbreviated in ISO language code.	C	When [eAIP-MENU-130] is implemented.
[eAIP-MENU-330]	Colour of language code for the currently selected language	C	When [eAIP-MENU-130] is implemented.
[eAIP-MENU-340]	Colour language code for the currently selected language	C	When [eAIP-MENU-130] is implemented.
[eAIP-MENU-350]	Colour language code for the currently unselected language	C	When [eAIP-MENU-130] is implemented.
[eAIP-MENU-360]	Open of section in currently selected language	C	When [eAIP-MENU-130] is implemented.
[eAIP-MENU-370]	Title of link to the current section of document in PDF format.		When [eAIP-MENU-150] is implemented.
[eAIP-MENU-380]	Display of pdf logo.		When [eAIP-MENU-150] is implemented.

[eAIP-MENU-390]	Use of Adobe ® pdf icon		When [eAIP-MENU-150] is implemented.
[eAIP-MENU-400]	Open of the page in pdf format – clicking on link.		When [eAIP-MENU-150] is implemented.
[eAIP-MENU-410]	Open of page in PDF format – clicking on icon.		When [eAIP-MENU-150] is implemented.
[eAIP-MENU-420]	Title of link to the of the publishing organisation.		When [eAIP-MENU-150] is implemented.
[eAIP-MENU-430]	Display of publishing organisation's logo.		When [eAIP-MENU-160] is implemented.
[eAIP-MENU-440]	Open of the organisation's website- clicking on name.		When [eAIP-MENU-160] is implemented.
[eAIP-MENU-450]	Open of the organisation's website- clicking on logo.		When [eAIP-MENU-160] is implemented.
[eAIP-MENU-460]	Title of AIP tabbed page.	M	
[eAIP-MENU-470]	Title as link to the AIP Table of contents	M	
[eAIP-MENU-480]	Open of the AIP Table of contents.	M	
[eAIP-MENU-490]	Colour of the AIP tab when it is unselected.	M	
[eAIP-MENU-500]	Colour of the AIP tab when it is selected.	M	
[eAIP-MENU-510]	Colour of the AIP title when the tabbed page is selected.	M	
[eAIP-MENU-520]	Font style of AIP title when the	M	

	tabbed page is selected.		
[eAIP-MENU-530]	Colour and font style of AIP title when the tabbed page is unselected and previously opened.	M	
[eAIP-MENU-540]	Appearance of AIP tab when selected.	M	
[eAIP-MENU-550]	Title of AMDT "Table of Contents"	M	
[eAIP-MENU-560]	Title as link to AMDT "Table of Contents".	M	
[eAIP-MENU-570]	Open of AMDT "Table of Contents".	M	
[eAIP-MENU-580]	Colour of AMDT tab when it is unselected.	M	
[eAIP-MENU-590]	Colour of AMDT tab when it is selected.	M	
[eAIP-MENU-600]	Colour and font style of AMDT title when the tabbed page is selected.	M	
[eAIP-MENU-610]	Colour and font style of AMDT title when the tabbed page is unselected and not previously opened.	M	
[eAIP-MENU-620]	Colour and font style of AIP title when the tabbed page is unselected and previously opened	M	
[eAIP-MENU-630]	Appearance of AMDT tab when selected.	M	
[eAIP-MENU-640]	Title of SUPs tabbed page.	M	
[eAIP-MENU-650]	Title as link to the SUPs "Table of Contents".	M	

[eAIP-MENU-660]	Open of SUPs "Table of Contents".	M	
[eAIP-MENU-670]	Colour of SUPs tab when it is unselected.	M	
[eAIP-MENU-680]	Colour of SUPs tab when it is selected.	M	
[eAIP-MENU-690]	Colour and font style of SUPs title when the title page is selected.	M	
[eAIP-MENU-700]	Colour and font style of the SUPs title when the tabbed page is unselected and not previously opened.	M	
[eAIP-MENU-710]	Colour and font style of SUPs title when the tabbed page is unselected and previously opened.	M	
[eAIP-MENU-720]	Appearance of SUPs tab when selected.	M	
[eAIP-MENU-730]	Title of the AIC title page.	M	
[eAIP-MENU-740]	Title as a link to the AICs "Table of Contents".	M	
[eAIP-MENU-750]	Open of AICs "Table of Contents"	M	
[eAIP-MENU-760]	Colour of AICs tab when it is unselected.	M	
[eAIP-MENU-770]	Colour of AICs tab when it is selected.	M	
[eAIP-MENU-780]	Colour and font style of AICs title when the tabbed page is selected	M	
[eAIP-MENU-790]	Colour and font style of AICs title when the tabbed page is	M	

	unselected and not previously opened.		
[eAIP-MENU-800]	Colour and font style of AICs title when the tabbed page is unselected and previously opened.	M	
[eAIP-MENU-810]	Appearance of AIC tab when selected.	M	
[eAIP-MENU-820]	Title of Search tabbed page.	C	When [eAIP-MENU-230] is implemented.
[eAIP-MENU-830]	Title as a link to search facility.	C	When [eAIP-MENU-230] is implemented.
[eAIP-MENU-840]	Open of Search facility.	C	When [eAIP-MENU-230] is implemented.
[eAIP-MENU-850]	Colour of Search tab when it is unselected.	C	When [eAIP-MENU-230] is implemented.
[eAIP-MENU-860]	Colour of search tab when selected.	C	When [eAIP-MENU-230] is implemented.
[eAIP-MENU-870]	Colour and font style of Search title when the tabbed page is selected.	C	When [eAIP-MENU-230] is implemented.
[eAIP-MENU-880]	Colour and font style of Search title when the tabbed page is unselected and not previously opened.	C	When [eAIP-MENU-230] is implemented.
[eAIP-MENU-890]	Colour and font style of Search title when the tabbed page is unselected and previously opened.	C	When [eAIP-MENU-230] is implemented.
[eAIP-MENU-900]	Appearance of Search tab	C	When [eAIP-

	when selected.		MENU-230] is implemented.
[eAIP-AIPT-010]	Inclusion of effective date on the AIP Table of Contents.	M	
[eAIP-AIPT-020]	Colour of effective date.	M	
[eAIP-AIPT-030]	Font style for effective date	M	
[eAIP-AIPT-040]	Font size for effective date	M	
[eAIP-AIPT-050]	Highlight of three parts of the AIP by a blue header.	M	
[eAIP-AIPT-060]	Colour of title of the AIP part.	M	
[eAIP-AIPT-070]	Part number in title.	M	
[eAIP-AIPT-080]	Inclusion of title of the part, in title.	M	
[eAIP-AIPT-090]	Expansion of the part when the Table of content is opened.	M	
[eAIP-AIPT-100]	Expansion of the part Table of the Contents tree.	M	
[eAIP-AIPT-110]	Collapse of the part Table of the content tree.	M	
[eAIP-AIPT-120]	Part title as a link.	M	
[eAIP-AIPT-130]	Open of part by clicking part link.	M	
[eAIP-AIPT-140]	Part Table of Contents lists each chapter in the part.	M	
[eAIP-AIPT-150]	Title of the chapter preceded by the name of the part.	M	
[eAIP-AIPT-160]	Number of the chapter in the title.	M	
[eAIP-AIPT-170]	Description of its contents in	M	

	the title of chapter.		
[eAIP-AIPT-180]	Default collapse of chapters in the Table of Contents tree.	M	
[eAIP-AIPT-190]	Expansion of chapter Table of contents tree.	M	
[eAIP-AIPT-200]	Collapse of chapter Table of contents tree.	M	
[eAIP-AIPT-210]	Chapter title as link.	M	
[eAIP-AIPT-220]	Open of chapter by clicking chapter link.	M	
[eAIP-AIPT-230]	Clicking on collapsed part or chapter.	M	
[eAIP-AIPT-240]	Title of NIL section preceded by "[NIL]".	M	
[eAIP-AIPT-250]	"NIL" under the section title for sections with no content.	M	
[eAIP-AIPT-260]	Ability to include additional supporting text for NIL sections.	O	
[eAIP-AIPT-270]	Availability of pdf formats of NIL section.	M	
[eAIP-AMDTT-010]	Inclusion of effective date of the AIP Amendment.	M	
[eAIP-AMDTT-020]	Colour of the effective date.	M	
[eAIP-AMDTT-030]	Font style of the effective date.	M	
[eAIP-AMDTT-040]	Font size of the effective date.	M	
[eAIP-AMDTT-050]	Grouping of changes in the amendment.	M	
[eAIP-AMDTT-060]	Display of group title for each group.	M	

me
MP

[eAIP-AMDTT-070]	Colour of the group title.	M	
[eAIP-AMDTT-080]	Background colour of group title for AIRAC amendment.	M	
[eAIP-AMDTT-090]	Background colour of group title for non-AIRAC amendment.	M	
[eAIP-AMDTT-100]	Inclusion of description for each group.	M	
[eAIP-AMDTT-110]	Inclusion of chapter number of the AIP where the amendment(s) has been made.	M	
[eAIP-AMDTT-120]	Inclusion of title of the affected chapter for each group.	M	
[eAIP-AMDTT-130]	Expansion of chapter "Table of Contents" tree.	M	
[eAIP-AMDTT-140]	Expansion of chapter by clicking the chapter title.	M	
[eAIP-AMDTT-150]	Collapse of chapter "Table of contents" tree.	M	
M[eAIP-AMDTT-160]	Collapse of chapter by clicking on the chapter title.	M	
[eAIP-AMDTT-170]	Listing of section of the chapter containing amendments.	M	
[eAIP-AMDTT-180]	Listing of sections number in the section listing.	M	
[eAIP-AMDTT-190]	Inclusion of section title in the sections listing.	M	
[eAIP-AMDTT-200]	Listing of amendments for each section.	M	

[eAIP-AMDDT-210]	Grouping of amendments by the nearest sub-section title.	M	
[eAIP-AMDDT-220]	Listing of nearest sub-section title.	M	
[eAIP-AMDDT-230]	Listing of the number of the nearest sub-section title.	O	
[eAIP-AMDDT-240]	Indication of individual changes in an amendment group.	M	
[eAIP-AMDDT-250]	Link to each change.	M	
[eAIP-AMDDT-260]	Location of links.	M	
[eAIP-AMDDT-270]	Display of selected change.	M	
[eAIP-SUPT-010]	Indication of the date the page was published.	M	
[eAIP-SUPT-020]	Colour of publication date.	M	
[eAIP-SUPT-030]	Font style for publication date.	M	
[eAIP-SUPT-040]	Font size for publication date.	M	
[eAIP-SUPT-050]	Inclusion of Numbe/Year for AIP SUP.	M	
[eAIP-SUPT-060]	Inclusion of AIP section (s) affected.	M	
[eAIP-SUPT-070]	Inclusion of period of validity.	M	
[eAIP-SUPT-080]	Inclusion of subject.	M	
[eAIP-SUPT-090]	Indication of AIP section (s) affected.	M	
[eAIP-SUPT-100]	AIP section affected as link.	M	
[eAIP-SUPT-110]	Open of eAIP session.	M	
[eAIP-SUPT-120]	Indication of the date from which the AIPSUP is valid.	M	

[eAIP-SUPT-130]	Indication of date for the end of the validity period.	O	
[eAIP-SUPT-140]	Separation of AIP SUPs in the list.	O	
[eAIP-SUPT-150]	Number/Year of the AIP SUP as a link.	M	
[eAIP-SUPT-160]	Opening of AIP SUP	M	
[eAIP-SUPT-170]	Control and update of AIP SUPs and the AIP sections.	C	When [eAIP-SUPT-100] is implemented.
[eAIP-AICT-010]	Indication of date the page was published.	M	
[eAIP-AICT-020]	Colour of publication date.	M	
[eAIP-AICT-030]	Font style for publication date.	M	
[eAIP-AICT-040]	Font size for publication date.	M	
[eAIP-AICT-050]	AICs grouped by series.	O	
[eAIP-AICT-060]	Expansion of AIC series.	C	When [eAIP-AICT-050] is implemented.
[eAIP-AICT-070]	Collapse of AIC series.	C	When [eAIP-AICT-050] is implemented.
[eAIP-AICT-080]	Inclusion of Number/Year.	M	
[eAIP-AICT-090]	Inclusion of date of publication date.	M	
[eAIP-AICT-100]	Inclusion of series.	M	
[eAIP-AICT-110]	Inclusion of subject.	M	
[eAIP-AICT-120]	Separation of each AIC in the list.	O	
[eAIP-AICT-130]	Number/Year of the AIC as a	M	

	link.		
[eAIP-AICT-140]	Opening of AIC.	M	
[eAIP-HELP-010]	Inclusion of help regarding the eAIP.	M	
[eAIP-HELP-020]	Inclusion of help regarding system requirements.	M	
[eAIP-HELP-030]	Inclusion of help regarding menu.	M	
[eAIP-HELP-040]	Inclusion of help regarding AIP tab.	M	
[eAIP-HELP-050]	Inclusion of help regarding the AMDT tab.	M	
[eAIP-HELP-060]	Inclusion of help regarding SUPs tab.	M	
[eAIP-HELP-070]	Inclusion of help regarding AICs tab.	M	
[eAIP-HELP-080]	Inclusion of help regarding Amendments.	M	
[eAIP-HELP-090]	Inclusion of help regarding the Search facility.	C	When [eAIP-MENU-230] is implemented.
[eAIP-HELP-100]	Inclusion of help regarding other features of the eAIP.	M	
[eAIP-HELP-110]	Inclusion of help regarding other features of the eAIP.	M	
[eAIP-HELP-120]	Inclusion of frequently asked questions section.	O	
[eAIP-HELP-130]	Inclusion of additional information.	O	
[eAIP-AIPC-010]	Location of part or section line.	M	
[eAIP-AIPC-020]	Inclusion of part title in header.	O	

[eAIP-AIPC-030]	Colour of part title.	M	
[eAIP-AIPC-040]	Colour of all other titles	O	
[eAIP-AIPC-050]	Case of part and section titles.	M	
[eAIP-AIPC-060]	Font size of part titles.	M	
[eAIP-AIPC-070]	Case of level 1 sub-sections.	M	
[eAIP-AIPC-080]	Case of level 2 sub-sections.	M	
[eAIP-AIPC-090]	Case of all other titles.	M	
[eAIP-AIPC-100]	Inclusion AIRAC amendment and non-AIRAC amendments tables in GEN 0.2.	M	
[eAIP-AIPC-110]	Inclusion of Number/Year for each Amendment.	M	
[eAIP-AIPC-120]	Inclusion of publication date for each amendment.	M	
[eAIP-AIPC-130]	Inclusion of effective date for each AIRAC amendment.	M	
[eAIP-AIPC-140]	Inclusion of signature column in GEN 0.2.	M	
[eAIP-AIPC-150]	GEN 1.7 – List of data not meeting the data requirements of ICAO Annex 15 [RD 1].	O	
[eAIP-AIPC-160]	GEN 1.7 – List not meeting data quality requirements of Arrête N° 001303/MINT [RD 5]	O	
[eAIP-AIPC-170]	Order of abbreviations.	O	
[eAIP-AIPC-180]	Access to abbreviations through fast access bar.	O	
[eAIP-AIPC-190]	List of aerodrome charts	O	
[eAIP-AIPC-200]	Addition of sections to		

	chapters.		
[eAIP-AIPC-210]	Change of table structure.	O	
[eAIP-AIPC-220]	Highlight of abbreviations in text.	O	
[eAIP-AIPC-230]	Display of hint for abbreviation.	C	When [eAIP-AIPC-220]
[eAIP-AIPC-240]	Inclusion of question mark on the cursor.	C	When [eAIP-AIPC-220]
[eAIP-AIPC-250]	Linking of sections.	O	
[eAIP-AIPC-260]	Colour of section links.	C	When [eAIP-AIPC-250]
[eAIP-AIPC-270]	Underlining of section links.	C	When [eAIP-AIPC-250]
[eAIP-AIPC-280]	Opening of linked sections.	C	When [eAIP-AIPC-250]
[eAIP-AIPC-290]	Ability to show amendments in eAIP text.	M	
[eAIP-AIPC-300]	Tick box to turn on and off display of amendments.	M	
[eAIP-AIPC-310]	Title of tick box.	M	
[eAIP-AIPC-320]	Showing / hiding amendments.	M	
[eAIP-AIPC-330]	Presentation of text when amendment turned on.	M	
[eAIP-AIPC-340]	Display of deleted text.	M	
[eAIP-AIPC-350]	Highlighting of deleted text - AIRAC.	M	
[eAIP-AIPC-360]	Highlighting of deleted text - non-AIRAC.	M	
[eAIP-AIPC-370]	Highlighting of added text -	M	

	AIRAC.		
[eAIP-AIPC-380]	Highlighting of added text – non-AIRAC.	M	
[eAIP-AIPC-390]	Display of changes to numbering.	M	
[eAIP-AMDTC-010]	Display of content for a change.	M	
[eAIP-AMDTC-020]	Highlighting for change.	M	
[eAIP-AMDTC-030]	Display of deleted text.	M	
[eAIP-AMDTC-040]	Direct change in graphic/image.	M	
[eAIP-AMDTC-050]	Display of change to graphic/image file.	M	
[eAIP-AMDTC-060]	Background for deleted text – AIRAC.	M	
[eAIP-AMDTC-070]	Background for added text – AIRAC.	M	
[eAIP-AMDTC-080]	Background for deleted text – non-AIRAC.	M	
[eAIP-AMDTC-090]	Background for added text – non-AIRAC.	M	
[eAIP-AMDTC-100]	Location of amendment text.	M	
[eAIP-SUPC-010]	Header of AIP SUP.	O	
[eAIP-SUPC-020]	Inclusion of name of the issuing organisation in SUP header.	M	
[eAIP-SUPC-030]	Inclusion of the publishing organisation in SUP header.	M	
[eAIP-SUPC-040]	Inclusion of postal address of publishing organisation in SUP header.	M	

[eAIP-SUPC-050]	Inclusion of indication that the document is an AIP SUP in SUP header.	M	
[eAIP-SUPC-060]	Inclusion of Number/Year of the AIP SUP in SUP header.	M	
[eAIP-SUPC-070]	Inclusion of effective date of AIP SUP in SUP header.	M	
[eAIP-SUPC-080]	Inclusion of publication date of the AIP SUP in SUP header.	M	
[eAIP-SUPC-090]	Inclusion of logo of the publishing organisation.	O	
[eAIP-SUPC-100]	Inclusion of telephone number of the publishing organisation in SUP header.	O	
[eAIP-SUPC-110]	Inclusion of fax number of the publishing organisation in SUP header.	O	
[eAIP-SUPC-120]	Inclusion of email address of publishing organisation in SUP header.	O	
[eAIP-SUPC-130]	Inclusion of website address of the publishing organisation in SUP header.	O	
[eAIP-SUPC-140]	Inclusion of address of the AFS in SUP header.	O	
[eAIP-SUPC-150]	Colour of header text.	M	
[eAIP-SUPC-160]	Header including subject of AIP SUP.	M	
[eAIP-SUPC-170]	Colour of subject header.	O	
[eAIP-SUPC-180]	Colour of subject header text.	M	
[eAIP-SUPC-190]	Case of subject header text.	M	

[eAIP-SUPC-200]	Colour of all sub-headings.	O	
[eAIP-SUPC-210]	Display of deleted SUP text – replacing previous SUP.	O	
[eAIP-SUPC-220]	Highlighting of deleted text – AIRAC SUP – replacing previous SUP.	O	
[eAIP-SUPC-230]	Highlighting of added text – AIRAC SUP – replacing previous SUP.	O	
[eAIP-SUPC-240]	Highlighting of deleted text – non-AIRAC SUP – replacing previous SUP.	O	
[eAIP-SUPC-250]	Highlighting of added text – non-AIRAC SUP – replacing previous SUP.	O	
[eAIP-AICC-010]	Header of AIC for administrative-related subject.	O	
[eAIP-AICC-020]	Header of AIC for ATC-related	O	
[eAIP-AICC-030]	Header of AIC for safety-related subject.	O	
[eAIP-AICC-040]	Header of AIC containing Danger Area Map.	O	
[eAIP-AICC-050]	Header of AIC containing maps/charts.	O	
[eAIP-AICC-060]	Inclusion of the name of issuing State in AIC header.	M	
[eAIP-AICC-070]	The name of the publishing organisation in AIC header.	M	
[eAIP-AICC-080]	Inclusion of postal address of the publishing organisation in AIC header.	M	
[eAIP-AICC-090]	Inclusion of indication that this	M	

	document is and AIC in AIC header.		
[eAIP-AICC-100]	Inclusion of Number/Year of the AIC in AIC header.	M	
[eAIP-AICC-110]	Inclusion of the publication date of the AIC in the AIC header.	M	
[eAIP-AICC-120]	Inclusion of the logo of the publishing organisation in AIC header.	O	
[eAIP-AICC-130]	Inclusion of telephone number of the publishing organisation in AIC header.	O	
[eAIP-AICC-140]	Inclusion of fax number of publishing organisation in AIC header.	O	
[eAIP-AICC-150]	Inclusion of email address of the publishing organisation in AIC header.	O	
[eAIP-AICC-160]	Inclusion of website address of the publishing organisation in AIC header.	O	
[eAIP-AICC-170]	Inclusion of address of the AFS in AIC header.	O	
[eAIP-AICC-180]	Colour of AIC header text.	M	
[eAIP-AICC-190]	Subject of AIC	M	
[eAIP-AICC-200]	Colour of subject header.	C	When [eAIP-AICC-010] – [eAIP-AICC-050] are implemented.
[eAIP-AICC-210]	Colour of subject header text.	M	
[eAIP-AICC-220]	Case of subject header text.	M	

[eAIP-AICC-230]	Colour of sub-headings.	O	
[eAIP-AICC-240]	Display of deleted text-replacing previous AIC	O	
[eAIP-AICC-250]	Highlight of deleted text – replacing previous AIC.	O	
[eAIP-AICC-260]	Highlight of added text – replacing previous AIC	O	
[eAIP-DIST-010]	Distribution of physical media containing new AIRAC AMDT and/or AIRAC SUP.	M	
[eAIP-DIST-020]	Inclusion of unique identifier on physical media labelling.	M	
[eAIP-DIST-030]	Inclusion of publication date of the eAIP on the physical media labelling.	M	
[eAIP-DIST-040]	Inclusion of state which has issued the eAIP on physical media labelling.	M	
[eAIP-DIST-050]	Inclusion of organisation that has published the eAIP on physical media libelling.	M	
[eAIP-DIST-060]	Inclusion of contacts details of the publishing organisation on physical media labelling.	M	
[eAIP-TECH-010]	Documentation of version of HTML.	M	
[eAIP-TECH-020]	Documentation of scripting language.	M	
[eAIP-TECH-030]	Documentation of Scripting language version.	M	
[eAIP-TECH-040]	Documentation of validator used.	O	

[eAIP-TECH-050]	Documentation of browser (s) tested with eAIP.	O	
[eAIP-TECH-060]	Documentation of browser (s) version (s) tested with the eAIP.	O	
[eAIP-TECH-070]	Documentation of PDF version used.	M	
[eAIP-TECH-080]	Documentation of PDF reader (s) tested with the eAIP.	O	
[eAIP-TECH-090]	Documentation of PDF reader (s) tested with eAIP.	O	